

MAY 1968

TAPE

RECORDING MAGAZINE

2¹/₂

1968 CONTEST WINNERS

FIRST DETAILS OF THE NEW
BRITISH EQUIPMENT

PLUS — Review of Vortexion CBL/T
AND — All Usual Features

THE BUDGET

AN OPEN LETTER
to
THE CHANCELLOR
What You Pay

Second class postage paid at
New York Post Office, N.Y.

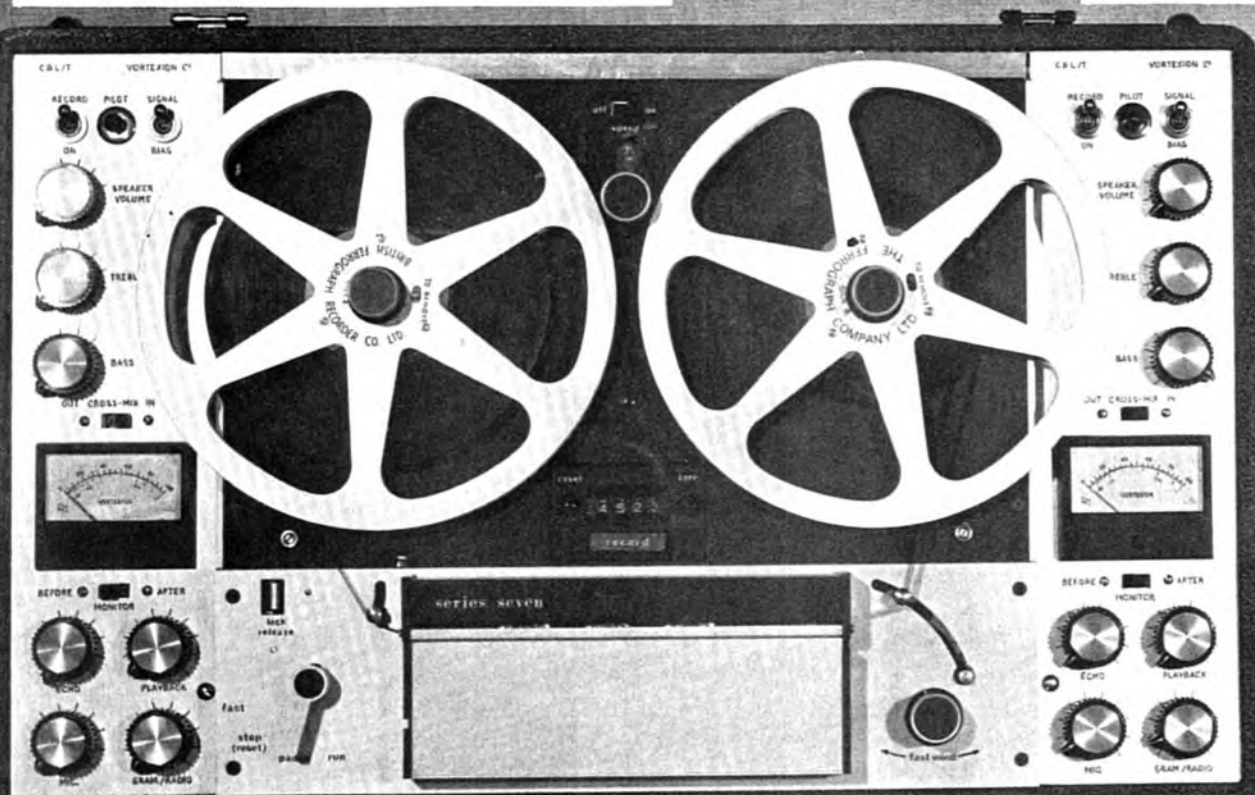



BASF are exhibiting at **Booth 55** and screening "The Timeless Track" in **Demonstration Room 149** at the Audio Fair, 18th—21st April, 1968.

New from BASF a low noise, high output tape for TOP QUALITY recording

From BASF comes the magnetic tape you've all been waiting for. Called PES 35 LH, this tape combines low background noise with a high modulation range at recording level. In recording terms, that means PES 35 LH will give you top-quality sound reproduction free of that irritating background 'hiss'—*whatever* tape recorder you use.

The neatest tool-kit yet

The all-in-one Hobby Box is compact, comprehensive and ideal for every splicing enthusiast. It contains: splicer; marking pencil; cutting blade; 33' of splicing tape 0.7" wide; 80' lengths of red, white and green leader tapes; 50 pieces of 6" metallised foil; 25 spool labels in green and red; 3 tape clips.

The range:

Spool diameter	Tape length
5"	900'
5½"	1200'
7"	1800'
8¼"	2400'
10"	3600'
10½"	4200'

SEE THEM
AT YOUR
DEALER—
NOW



BASF United Kingdom Limited,
5a Gillespie Road, London, N.5. Tel: (01) 266 2011.

We'd like you to say a few words...

TK247 de luxe: solid state stereo. Four-track, two-speed. (21 transistors, 4 diodes.) Facilities for complete stereo playback *and* recording. Multi-synchronous recordings and monitoring through built-in speakers or headphones. 2 x 4W output stages, 4 speakers. Transfer mixing control. Wow and flutter $\pm 0.12\%$ at 7 1/2 i.p.s., $\pm 0.15\%$ at 31 i.p.s. Frequency response 40-16,000 Hz at 7 1/2 i.p.s. Illuminated VU input meters. Automatic tape stop. Up to 8 hours' playing time per spool. Stylish cabinet in graphite and silver steel trim. Price: 122 gns.



TK2200: perfect-recording playback anywhere. Fully transistorised. (18 transistors, 9 diodes.) Two contra-rotating flywheels to stabilise tape speed. Brushless DC motor. Wow and flutter $\pm 0.4\%$ at 1 1/2 i.p.s., $\pm 0.25\%$ at 31 i.p.s. Frequency response 40-15,000 Hz at 31 i.p.s. Takes 5" spools. Recordings can be monitored. Remote control stop/start from microphone. VU recording level meter, automatic stop, etc. Converts to mains supply using Grundig's TN12 power pack. Price: 92 gns.



C200: Grundig precision in a portable recorder. Fully transistorised. (12 transistors, 3 diodes.) Unique, reliable brushless DC motor. Reproduction of VHF quality. Cassettes give up to 90 minutes' playback. Easy-G control: stop, start, pause, fast forward/rewind, and cassette ejection. Plus recording level control, and continuously variable tone control. Frequency response 80-10,000 Hz; wow and flutter $\pm 0.4\%$; output power 800mW. Vertical or horizontal operation. Features the "Instrument Look." Sockets for external power supply, extension speaker, remote control, etc. Weighs only 41lb. Price: 47 gns.



"Testing, testing, one, two, three"

Go along to your local Grundig dealer, and ask him to put our latest tape-recorders through their paces. When you listen to a Grundig, you hear the tape, not the recorder. Sighs or symphonies, a Grundig plays back *exactly* what you record. So say a few words to a brand-new Grundig. We want to impress you. Grundig make a complete range of tape-recorders, up to 179 gns. One of them's right for you.

MAIL THIS COUPON FOR FURTHER DETAILS
To: GRUNDIG (Great Britain) LTD., Dept TM 6, London, S.E.26.
Please send me, completely free, "The Sound of Grundig" full-colour tape-recorder leaflet.

NAME _____

ADDRESS _____

TM6

IMMEDIATE DELIVERY!

K. J. ENTERPRISES

EVERYTHING AUDIO!

BRITAIN'S PREMIER MAIL-ORDER RECORDING TAPE SPECIALISTS

IMMEDIATE 24 HOUR SERVICE ON ADVERTISED LINES

FULL CASH REFUND GUARANTEED

SEND TODAY AND SAVE!

BRANDED TAPES

20% OFF

**BASF—EMI—GRUNDIG—PHILIPS
SCOTCH—AGFA—KODAK**

STANDARD PLAY	LIST PRICE	OUR PRICE
5" 600'	21/-	16/10
5½" 900' } Except	28/-	22/6
7" 1,200' } Agfa	35/-	28/-

LONG PLAY	LIST PRICE	OUR PRICE
3" 210'	9/-	7/3
(Not Scotch or Kodak)		
3" 300'	9/6	7/6
(Scotch only)		
3½" 300'	12/-	9/6
(Kodak only)		
4" 450'	14/6	11/8
(Except Kodak)		
4½" 600'	21/-	16/10
(BASF, Agfa only)		
*5" 900'	28/-	22/6
*5½" 1,200'	35/-	28/-
*7" 1,800'	50/-	35/-
8½" 2,400'	72/6	58/-
(BASF, Scotch only)		
10" 3,280'	85/-	68/-
(Agfa only)		
10" 3,600'	95/-	76/-
(BASF only)		
10½" 4,200'	112/-	90/-
(Agfa, BASF only)		

SCOTCH DYNARANGE (L/P)	LIST PRICE	OUR PRICE
5" 900'	32/3	25/10
5½" 1,200'	40/6	32/6
7" 1,800'	57/6	46/-
8½" 2,400'	83/6	66/10

COMPACT CASSETTES	LIST PRICE	OUR PRICE
C.60	17/6	14/-
C.90	25/-	20/-
C.120	33/6	27/-

Grundig Tape available only where marked with asterisk.
Postage and Packing 2/-. ORDERS OVER £3 POST FREE

FERROGRAPH TAPE—20% OFF!

Brand New. Fully guaranteed and in normal manufacturer's pack.	LIST PRICE	ONE	THREE	SIX
BN7 1,200' on 7" reel (Dynarange)	50/-	40/-	117/6	230/-
BN8 1,800' on 8½" reel (Dynarange)	71/-	57/-	168/-	330/-
BL7 1,800' on 7" reel (Dynarange)	70/-	56/-	165/-	324/-
BL8 2,400' on 8½" reel (Dynarange)	90/-	72/-	213/-	420/-

Post and Packing 2/-. ORDERS OVER £3 POST FREE.

ILFORD TAPE NEAR HALF PRICE

A BULK PURCHASE OF PREMIUM GRADE, TOP QUALITY, POLYESTER MAGNETIC TAPE FROM ONE OF THE WORLD'S FOREMOST EXPERTS IN FILM COATING TECHNOLOGY, WITH FULL LEADER, STOP FOIL, POLYTHENE WRAPPING, AND IN ORIGINAL MANUFACTURER'S BOXES. AVAILABLE IN LONG-PLAY BASE ONLY AT THESE BARGAIN PRICES.

	One	Three	Six
900' on 5" reel	List Price 28/-	16/6	48/-
1800' on 7" reel	List Price 50/-	32/6	95/-

Please add 2/- P. & P. ORDERS OVER £3 POST FREE

SENSATIONAL NEW HALF-PRICE OFFER!

A bulk purchase of top quality Recording Tape manufactured by one of the country's leading makers. A polyester based tape with superlife black coating. Polythene wrapped boxed and fully guaranteed. Available while stocks last in one size only.

1800' on 7" reel Long Play	Normal Value	ONE	THREE	SIX
	50/-	26/-	72/-	150/-

Postage and Packing 2/-. ORDERS OVER £3 POST FREE

AMPEX TAPE 25% OFF

BRAND NEW, FULLY GUARANTEED & IN NORMAL MANUFACTURER'S PACK '500' SERIES AUDIO TAPE (MYLAR BASE)

TYPE	DESCRIPTION	LIST PRICE	ONE	THREE	SIX
541-9	900' L/P 5" reel	28/-	21/-	61/6	120/-
541-12	1,150' L/P 5½" reel	35/-	28/-	82/6	162/-
541-18	1,800' L/P 7" reel	50/-	32/6	96/-	189/-
551-12	1,200' D/P 5" reel	42/-	35/-	103/6	204/-
551-16	1,650' D/P 5½" reel	56/-	45/-	133/6	264/-
551-24	2,400' D/P 7" reel	72/6	55/-	163/6	324/-

'600' SERIES PROFESSIONAL AUDIO TAPE (MYLAR BASE)

	LIST PRICE	ONE	THREE	SIX	
641-9	900' L/P 5" reel	30/6	23/-	66/6	127/6
641-18	1,800' L/P 7" reel	52/6	39/6	116/-	226/-
651-12	1,200' D/P 5" reel	46/-	34/6	101/-	197/-
651-24	2,400' D/P 7" reel	80/-	60/-	177/-	348/-

Post & Packing 2/-. Orders over £3 Post Free

N.B.—OTHER TYPES & SIZES AVAILABLE INCLUDING THE INEXPENSIVE "WHITE BOX" SERIES

SPECIAL OFFER COMPACT CASSETTES

"MC 60"

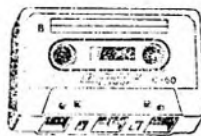

Compact Cassettes with 60 mins. playing time. Brand new and packed in normal plastic library box—available at this exceptional price.

NORMALLY 17/6 OUR PRICE 13/-

Standard pattern to fit Philips, Stella, Elizabethan, Dansette, Sanyo, etc.

3 for 38/3 6 for 75/- 12 for 144/-

Post & Packing 2/-

Orders over £3 Post Free

BASF TAPE—30% Reduction

A SPECIAL OFFER OF THIS FAMOUS PREMIUM GRADE TAPE Brand new, boxed, with full leader, stop foil and polythene sealed. Multiples of three 4" size can be supplied in the BASF 3 compartment plastic library cassettes at no extra cost.

Type	Description	List Price	One	Three	Six
LGS 26	600' D/P 4" reel	25/-	17/-	49/-	93/-
LGS 26	1200' D/P 5" reel	42/-	29/6	86/-	166/-
LGS 26	1800' D/P 5½" reel	55/-	38/6	112/6	219/-
LGS 26	2400' D/P 7" reel	77/6	49/6	145/6	285/-

Post and Packing 2/-. ORDERS OVER £3 POST FREE.

TRIPLE PLAY TAPE—40% OFF!

A large purchase from TWO world renowned manufacturers enables us to make this unique half-price offer. Brand new, fully guaranteed, premium grade Polyester Base Tape with FULL LEADER and stop foil. In original maker's boxes and polythene wrapped at these EXCEPTIONALLY LOW PRICES.

	List Price	One	Three	Six
450' on 3" reel Gevasonor	22/-	14/-	40/6	78/-
600' on 3" reel Gevasonor	27/6	17/6	51/-	99/-
900' on 4" reel Gevasonor	39/-	24/6	72/-	140/-
2400' on 5½" reel Zonal	90/-	55/6	165/-	324/-

Post and Packing 2/-, ORDERS OVER £3 POST FREE.

20% off all Grundig and Philips equipment.

SEND FOR LISTS OF OTHER TAPE AND HI-FI BARGAINS

K. J. ENTERPRISES, (Dept. T), 17 THE BRIDGE, WEALDSTONE, MIDDLESEX (OPPOSITE HARROW & WEALDSTONE STATION) 01-427 0395 (CLOSED P.M. SAT.) REFUND GUARANTEE

FREE

Our New Illustrated catalogue sent entirely free on request. Britain's most specialized comprehensive range of recording tape and accessories. 20,000 reels always in stock with reductions ranging up to 50%.

**The best
from
Tandberg**

**The Series 12
stereo record and
playback system; Series 6X
stereo tape deck
and Tandberg
range of hi fi loudspeakers**

These products represent the peak of Tandberg audio engineering and craftsmanship. Years of technical know-how and research. Pride in each and every one that leaves the factory.

Series 12
Fully transistorised. Power output of 2 x 10 watts. Accepts ceramic or crystal pickups, radios or external loudspeakers by means of DIN or phono contacts. Built-in FM multiplex filters. Centre channel and pre-amp outputs. Twin electric beam indicators. Plug-in printed panels. 2 or 4 tracks.

Series 6X
Separate record, playback, erase and bias heads. Signal to noise ratio 55dB. Built-in multiplex filters. Centre channel output for simultaneous playback of two tracks. Fully transistorised oscillator circuit. Cathode follower outputs. On

and off tape monitoring. Sound on sound facilities. Exceptional frequency response at low speeds. 2 or 4 tracks.

Tandberg Hi-Fi Loudspeakers

Six superb models finished in Burma teak. Excellent in conjunction with any of the Tandberg range of tape recorders and decks. Or as a part of a Hi-Fi system.

Elstone Electronics Limited,
Hereford House,
Vicar Lane, Leeds, 2.

move up to

Tandberg



YOU'VE READ THE REVIEWS - NOW HEAR THE 'DITTONS' FOR YOURSELF AT THE AUDIO FAIR



If you have not had the stimulating experience of hearing either the Ditton 10 or 15 bookshelf loudspeakers, come and listen for yourself at this year's AUDIO FAIR. Hearing's believing! You'll be amazed at the sensitivity and range of response from such compact speakers.

DITTON 10

The most sophisticated mini-speaker on the market. Response from 35-15,000Hz, impedance 3/5 or 15 ohm versions, power handling 10 watts. Truly bookshelf size: 12 $\frac{3}{4}$ " x 6 $\frac{3}{4}$ " x 8 $\frac{1}{4}$ ".

DITTON 15

Just listen to Gordon J. King's summary in a February 'Hi-Fi Sound' Review: "I have no reservations whatever in thoroughly recommending this outstanding loudspeaker to all wishing to obtain large-speaker sounds from a modest 21" x 9 $\frac{1}{2}$ " x 9 $\frac{1}{4}$ " of enclosure". Suffice it to add that this is a 3 drive unit incorporating the famous ABR (Auxiliary Bass Radiator), 8" bass unit and the HF 1300 for treble notes. Full power response from 15,000 right down to 30Hz—the threshold of audible sound.

NEW FROM CELESTION -

We will be demonstrating a remarkable new loudspeaker at the Fair. Be sure not to miss the opportunity of being among the first to hear this superb new addition to the Ditton range.

So now you have an even greater choice of superb Ditton loudspeakers, from miniature bookshelf to professional standard. For the home constructor, Celestion offer a wide range of drive units.



Celestion loudspeakers — for the perfectionist



See us . . . HEAR US . . . at the AUDIO FAIR, April 18th-21st.

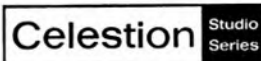

HOTEL RUSSELL, W.C.2. Booth 22, Demonstration room 534

Rola Celestion Ltd., Ferry Works, Thames Ditton, Surrey. Telephone: 01-398 3402

New from Tandberg

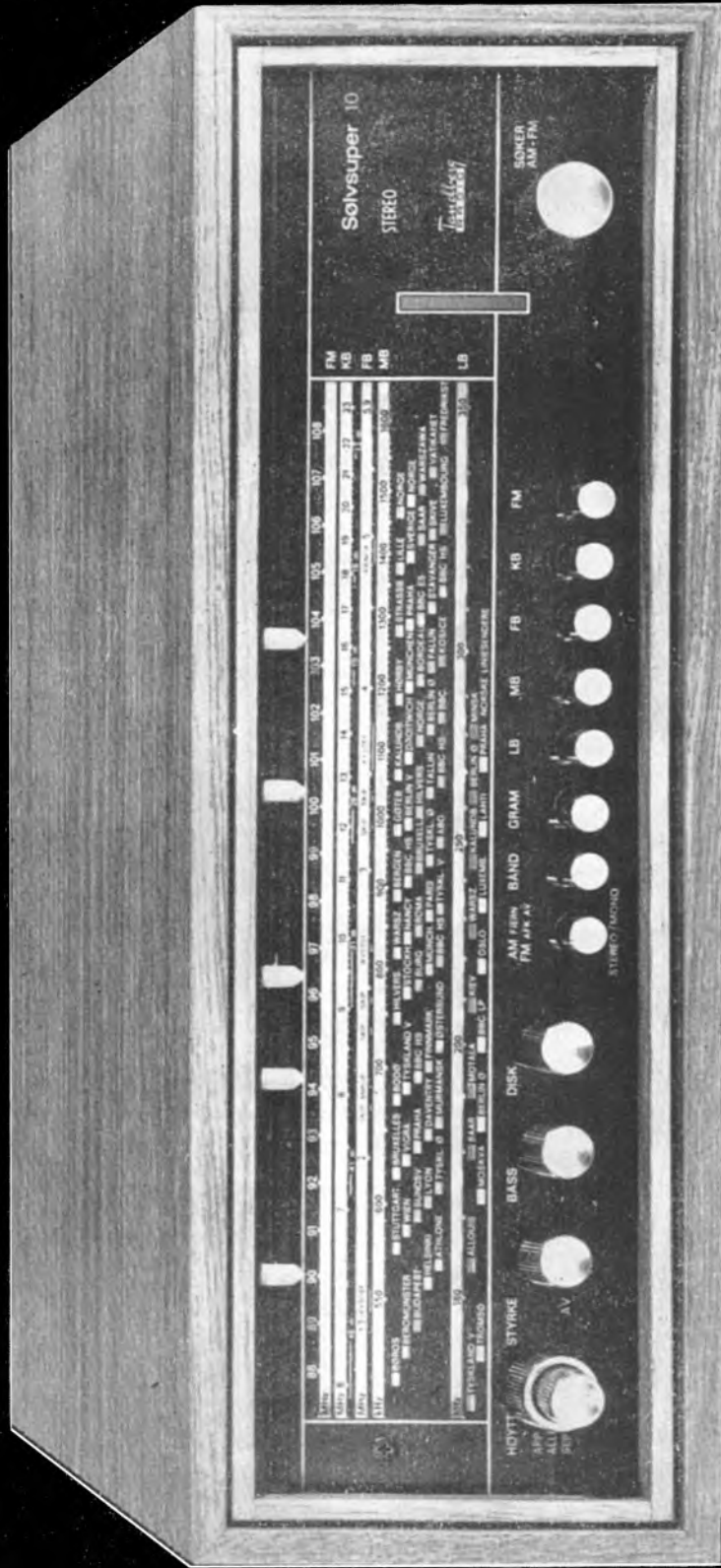

Solvsuper 10.71 combined FM/AM Tuner and Stereo Amplifier

It's all there. Everything the heart of your Hi-Fi system should have. A 12 watt stereo amplifier. An exceptional FM/AM tuner with provision for a stereo reception decoder. Combined in an elegant low line teak case.

The Solvsuper 10.71 incorporates these features: —

- ★ 5 wavebands: long, medium, short, coastal and FM.
- ★ Automatic frequency control on FM.

- ★ Push button selection of wavebands, or external gramophone tape recorder etc.
- ★ Separate bass and treble controls.
- ★ Adjustable FM station indicators.
- ★ Separate gain controls on each channel.
- ★ Electronic beam tuning indicator.
- ★ 2 x 6 watts output.
- ★ 15" long x 9" wide x 5 1/4" high.
- ★ £65.0.0.

The Solvsuper is also available in two other versions: —

- 10.70 with a single built in speaker (mono) £57.0.0.
- 10.72 with two built in speakers (stereo) £71.0.0.

Elstone Electronics Limited,
Hereford House,
Vicar Lane, Leeds 2.

move up to
Tandberg

THE MAN WHO PROVED OYSTERS CAN SING!



Oysters can sing. Dick Kenny in the U.S.A. has not only listened to oysters singing, as can be seen from this picture, but has also recorded them on tape. He now owns hundreds of micro-noises of this kind, including flies walking about, the sound made by prawns and falling snow-flakes.

Pedagogic College Himalaya region taken systematic sponsored by with him some it 1,200 Agfa-knowledge he last 12 in Otto founded as able

record of it had probably never been made. It was held in the sparsely lit courtyard of a temple where several hundred members of the sect were gathered round the area reserved for the dancing because the songs and instruments were rather unsatisfactory. I kept suppressed to some extent in front of the recording (he had rendered

... and also recorded the 'micro-sounds' of flies, prawns, moonbeams and falling snow! Extraordinary feats by an extraordinary man—nicknamed by his hundreds of friends as 'the crazy tapeworm'! Read all about him in the latest issue of Agfa Magnetron Magazine. True stories like this, technical features and a host of tips for the tape enthusiast can be found within its pages. Every issue also contains a wealth of information about the wide range of Agfa Magnetron tapes and useful accessories you can buy. It illustrates the benefits of low noise level without print-through, low distortion level, consistency, and the extreme tensile strength of all Agfa Magnetron tapes.



PROVED BY THE PROFESSIONALS

Get your FREE copy of the latest Agfa Magnetron Magazine, and hear for yourself the professional sound quality of Agfa Magnetron recording tapes.

STAND 37 & ROOM 353
at the AUDIO FAIR

or write to Magnetic Tape Division, Agfa-Gevaert Ltd., Great West Road, Brentford, Middlesex.

AGFA MAGNETON RECORDING TAPES

AKAI SPECIALISTS



FULL RANGE OF AKAI MODELS IN STOCK INCLUDING THE LATEST 1710 AND M9

We also stock a large selection of tapes and micro-phones, etc., and the full range of accessories for all AKAI models.

NORTH LONDON TAPE RECORDER CENTRE

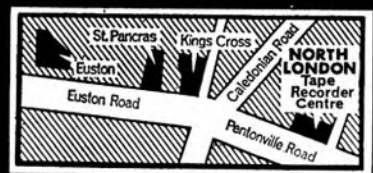

242/4 PENTONVILLE ROAD, LONDON, N.1.

Telephone: **TERminus 8200**
Open Monday to Saturday 9 a.m. to 6 p.m.

EVERY LEADING TAPE RECORDER IN STOCK

Ampex, B. & O., Brenell, E.M.I., Elizabethan, Ferguson, Ferrograph, Grundig, Loewe-Opta, National, Nunsound, Philips, Repts. Revox, Sanyo, Sharp, Sony, Tandberg, Telefunken, Truvox, Uher, Van der Molen, Vortexion, Wyndsor, etc.

EXPERT ADVICE & SERVICE

Ray Churchouse and his staff are all 100 per cent Tape Recorder enthusiasts and are able to give you expert advice and technical assistance based upon years of selling every make and type of Tape Recorder.



EASY TO GET TO

THE NORTH LONDON TAPE RECORDER CENTRE is situated only 100 yards from easy-to-get-to Kings Cross and St. Pancras main line stations (see map)

New
from
Tandberg

The Series 15

The new Series 15 combines Tandberg's world renowned qualities of faithful sound reproduction, reliability and compact modern design at a quite remarkably low price. It incorporates many superb features:—

- ★ Programme mixing facilities with separate controls for microphone and line inputs.
- ★ 10 watts output using an external speaker.
- ★ Volume control for monitoring whilst recording at loudspeaker level.

- ★ Loudspeaker selector switch providing choice of playback through internal speaker, or external speaker or both simultaneously.
- ★ Three speeds.
- ★ 4 digit illuminated counter with instant reset button.
- ★ Pause control gives instant stop/start.
- ★ Separate Bass and Treble lift and cut controls.
- ★ Signal to noise ratio 55db below maximum recording level.

- ★ Frequency response:—
 - 7 1/2 ips : 30-20,000 Hz (± 2dB40-16,000 Hz)
 - 3 1/2 ips : 30-13,000 Hz (± 2dB50-10,000 Hz)
 - 1 7/8 ips : 30-7,000 Hz (± 2dB60-5,000 Hz)

Elstone Electronics Limited,
Hereford House,
Vicar Lane, Leeds 2.

Tandberg
move up to

Series 15 from 69 1/2 guineas.

whatever the make...

4-TRACK STEREO MONO

	Deposit £ s. d.	12 Monthly Payments £ s. d.	Cash Price Gns.
Philips EL 3312	14 15 0	3 11 8	55
Ferguson 3232	18 2 3	4 10 7	69
Sony TC200	18 18 0	4 14 6	72
Philips EL3555	19 13 9	4 18 6	75
Akai 1710	20 14 9	5 3 9	79
Tandberg 74	24 8 3	6 2 1	93
Sony TC260	24 0 0	5 18 4	95
Tandberg Series 12	27 11 3	6 17 10	105
Revox 736 2- or 4-T	31 4 9	7 16 3	119
Sony TC 530	31 12 6	7 18 2	120
Akai M8	32 16 3	8 4 1	125
Beocord 2000K De Luxe	32 16 3	8 4 1	125
Beocord 2000T De Luxe	33 17 3	8 9 4	129
Akai X300	48 11 3	12 2 10	185
Akai X355	62 14 9	15 3 9	239

4-TRACK MONAURAL

Ferguson 3224	6 11 3	1 12 10	25
Fidelity Playtime 4...	7 1 9	1 15 6	27
Fidelity Playmatic 4...	8 2 9	2 0 9	31
Elizabethan LZ34	8 18 6	2 4 8	34
Ferguson 3218	8 18 6	2 4 8	34
Telefunken 201	9 17 0	2 8 4	37
Ferguson 3222	9 3 9	2 6 0	35
Philips EL4305	9 9 0	2 7 3	36
Grundig TK140	10 2 2	2 10 7	38½
Philips EL4306	11 0 6	2 15 2	42
Ferguson 3214	11 11 0	2 17 9	44
Truvox 44	12 6 9	3 1 9	47
Ferguson 3216	12 17 3	3 4 4	49
Tandberg 843	15 9 9	3 17 6	59
Philips EL3556	16 5 6	4 1 5	62
Truvox R104	23 7 3	5 16 10	89

TANDBERG model I242

Output 10 watts per channel. All Transistor. 2 built-in Loudspeakers. Built-in Multiplex filter. Separate Bass and Treble controls. 4 digit Counter. 2- or 4-Track. De luxe aluminium-framed carrying case with removable cover. Price 112 gns.

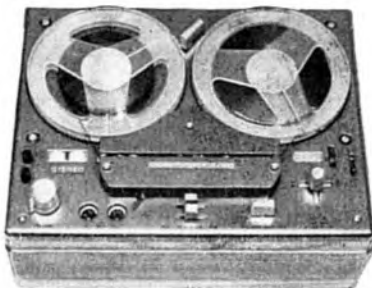

Tandberg Model I241 (as illustrated) Price 105 gns. in Teak. 2- or 4-Track.

TANDBERG 64X TAPE UNIT

Four head system. Sound on Sound. Teak cabinet. Price 118 gns. Deposit £33 18s. 0d. 12 monthly payments of £7 10s. 0d.

STEREO TAPE UNITS

	Deposit £ s. d.	12 Monthly Payments £ s. d.	Cash Price Gns.
Sony TC250A	14 19 3	3 14 10	57
Sony TC350	19 13 9	4 18 6	75
Akai 3000D	22 0 0	5 6 8	£86
Beocord 1500 De Luxe	25 9 3	6 7 4	97
Tandberg 64X	33 18 0	7 10 0	118
Revox 77CS	36 19 0	9 1 8	139
Revox 77CSVY	41 19 0	10 8 4	159

MAINS TWIN TRACK

Truvox R102	23 7 3	5 16 10	89
Brenell V/3 'M'	24 8 3	6 2 1	93
Ferroglyph 631	24 18 9	6 4 9	95
Ferroglyph 631/H	26 5 0	6 11 3	100

SPECIAL OFFER 10 gns. OFF LATEST MODEL REPS M10 4-TRACK

10 watts output 3 speeds Monitor on internal speaker Large record level meter Separate Bass and Treble Microphone, Tape and Radio Lead. BRAND NEW. 2-year Guarantee.

List price 69 gns. **OUR PRICE 59 gns.** Deposit £15.9.9 and 12 payments of £3.17.6

INTEREST FREE H.P. TERMS. OPEN SATURDAY 6 p.m. FRIDAY 6-30 p.m. IF UNABLE TO CALL WRITE FOR BROCHURES. PART EXCHANGES. ALSO 18 AND 24 MONTHLY TERMS

THE RECORDER CO

this is the name

(DEPT. T) 186-188 WEST END LANE, WEST HAMPSTEAD, LONDON, NW6
Telephone: 01-794 4977

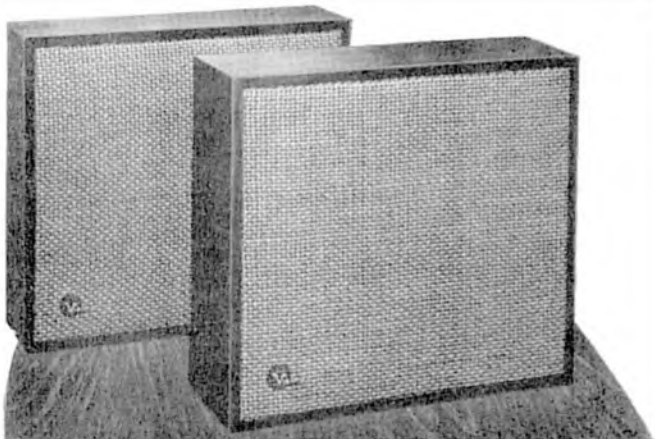

Up-grade your sound . . .

Viking 4400 loudspeakers, with 60 watts of music power built into them and a frequency range of from 40 to 17,000 cps bring smooth natural sound; deep bass, realistic mid-range and clear silky highs.

Each enclosure contains a super quality 8 in. speaker and a 3 in. tweeter with a 2,500 cps crossover. The built in amplifiers have volume control, bass control and headphone jack. An ideal addition to any tape deck, tuner or record player, can even be added to your television or sound movies. £49.10.0. Plus P.T. Send for full details and name of nearest stockist.

U.K. Distributors.
Transatlantic Music Tapes
(Distributors) Ltd.,
Bristol & West House,
Salisbury, Wilts.

Visit the Audio, Fair 18-22 April.

See and hear Viking equipment at the MORTON HOTEL, opposite entrance to Fair.



TELEX COMBO COMBINES SOUND PURITY WITH EASY LISTENING

Joan Baez or Beethoven, Brubeck or Brahms, everything sounds better through the acoustically matched speakers in this new Telex stereo headphone.

Wide range sound, distortion free purity, extra bass response and superb highs mean a guarantee of greater enjoyment of all music. Lightweight for comfort, quality built for sound, made for the pleasure of easy listening.

SEND FOR FULL DETAILS

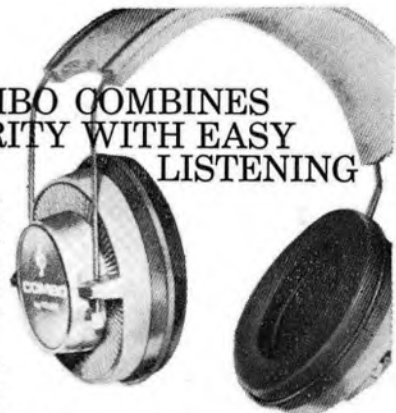

Frequency response 10 to 15,000 cps. Impedance 3-16 ohms. Max continuous input power 10 watts. Distortion at normal listening level less than 1 per cent. Weight 12 oz. Foam filled vinyl ear cushions. Whatever you need in headphones, Telex has it. The largest selection in the world.

SEE OUR EXHIBIT AT THE MORTON HOTEL WOBURN PLACE DURING THE AUDIO FAIR



U.K. Distributors
Transatlantic Music Tapes (Distributors) Ltd., Bristol & West House, Salisbury, Wilts

SHARP

to the point of perfection



Model RD 505. Solid state all transistor tape recorder, twin track, two speeds. Superb recording reproduction with outstanding simplicity of control. Entirely portable, will operate anywhere from internal batteries or AC mains. Designed to play or record in any position. Remote control switch on microphone allows full flexibility in use. Dimensions 12" x 10" x 4". Additional features include three digit tape counter, fully variable tone control, large internal speaker, automatic or manual level control and level/battery meter. Comes complete with dynamic microphone recording lead, earphone, batteries (six x EverReady LPU2 or equivalents). 5" reel of tape and empty spool. **£39 18 0**

THE SETS WITH THE 5-YEAR GUARANTEE

SHARP



SALES & SERVICE

15/18 WORSLEY ROAD, SWINTON, MANCHESTER
Telephone SWinton 3232 (5 lines)

For further details and leaflet contact:
SHARP SALES & SERVICE, 15/18 WORSLEY ROAD, SWINTON, LANCs.
Tel: SWinton 3232 (5 lines)

Name _____

Address _____

TRM 5

AFTER THE FAIR ... come and make your choice in London's leading Audio Centres

Come and see the widest range anywhere of the newest Hi-Fi and Tape—make your choice in comfort with specialist skilled advice ready at your elbow.

Interest Free Terms? of course!

Lowest permitted deposits, interest-free terms, free insurance, carriage and packing, unrivalled stocks and unprejudiced technical advice all help to make the most of your Hi-Fi or Tape purchase and to ensure your genuine satisfaction and lasting pleasure. (Please note we are unable to offer interest-free terms on Tape Recorders offered at pre-Budget prices while stocks last.)

Mail Order? This is an R.E.W. speciality. Fast, free van service anywhere in Greater London, vast stocks to ensure that your requirements can usually be met immediately without frustrating delays and disappointments.

Looking for a bargain? You will always find a wide range of equipment at our Headquarters Showrooms in Upper Tooting Road, often exclusive to R.E.W., at unrepeatable and unbeatable low prices.

We specialise in Part Exchange. If you have good quality equipment for disposal you can be sure of a generous and fair offer from R.E.W., or the maximum allowance against new equipment.

New extended showrooms in London's West End. You will find us just opposite the Astoria Cinema in Charing Cross Road, at 146. You will find we have the finest and most up-to-date equipment the world has to offer, from Britain, U.S.A., Japan, Scandinavia and the Continent. Bigger and better demonstration facilities and skilled, experienced staff ready with advice if required will make your choice easier and more rewarding.

Specially trained staff, too, at our Headquarter Showrooms in Upper Tooting Road, plus the same unrivalled selection from which you can make your choice. Over 400 Tape Recorders alone in stock here!

Overseas Visitors will find our Personal Export Service really helpful. Equipment can be despatched immediately free of U.K. Purchase Tax. Careful, experienced packing, fast service and prompt delivery arranged anywhere in the world.

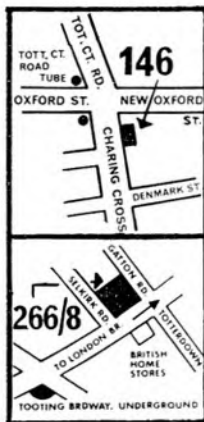

Gt. Britain's Largest Hi-Fi and Tape Recorder Dealers!

REW R·E·W (EARLSFIELD) LTD. ★ LEADERS IN MAIL ORDER HI-FI ★

● **HEADQUARTER SHOWROOMS AND MAIL ORDER:** DEPT. T.R.M., 266-8 UPPER TOOTING ROAD, LONDON, S.W.17. Tel.: 01-672 8267 or BAL 9175
● **WEST END SHOWROOMS:** 146 CHARING CROSS ROAD, LONDON, W.1. Tel.: 01-836 3365 (opposite Astoria Cinema)

**PRE-BUDGET
PRICES !
Save 33¹/₃ % P.T. !**

Akai M9 Stereo Tape Recorder, £159 or £53 deposit and 12 monthly payments of £9.14.4. Total HP price £169.12.0.



AKAI 1710W
Completely self-contained 4-track stereo machine, latest model. £89.10.0 or £30.10.0 deposit and 12 monthly payments or £5.4.0, a Total H.P. price £95.8.0.

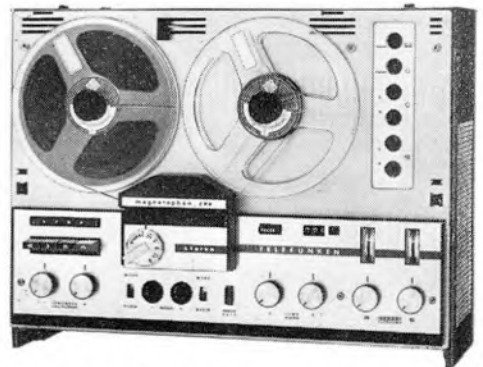

Telefunken 204E Stereo Tape Recorder. List price 106 gns. £34.6.0 deposit and 12 monthly payments of £7.1.2. Total HP price £119.

See and hear the latest developments:

AMPLIFIERS & TUNERS BY: AKAI ARENA ARM-STRONG B & O CHAPMAN DECCA FISHER GOODMAN'S GRUNDIG LEAK PHILIPS PYE QUAD RADFORD ROGERS SANSUI TELETON.

LOUDSPEAKERS BY: ARENA B & O FISHER GOODMAN'S KEF LEAK PHILIPS ROGERS TANNOY WHARFEDALE.

TAPE RECORDERS BY: AKAI AMPEX B & O BRENELL CINECORDER EMI FERGUSON FERROGRAPH FICORD ELIZABETHAN GRUNDIG HITACHI IOWA LUXOR OPTACORD PHILIPS REVOX SANYO SONY TANDBERG TELEFUNKEN UHER WYNDSOR.

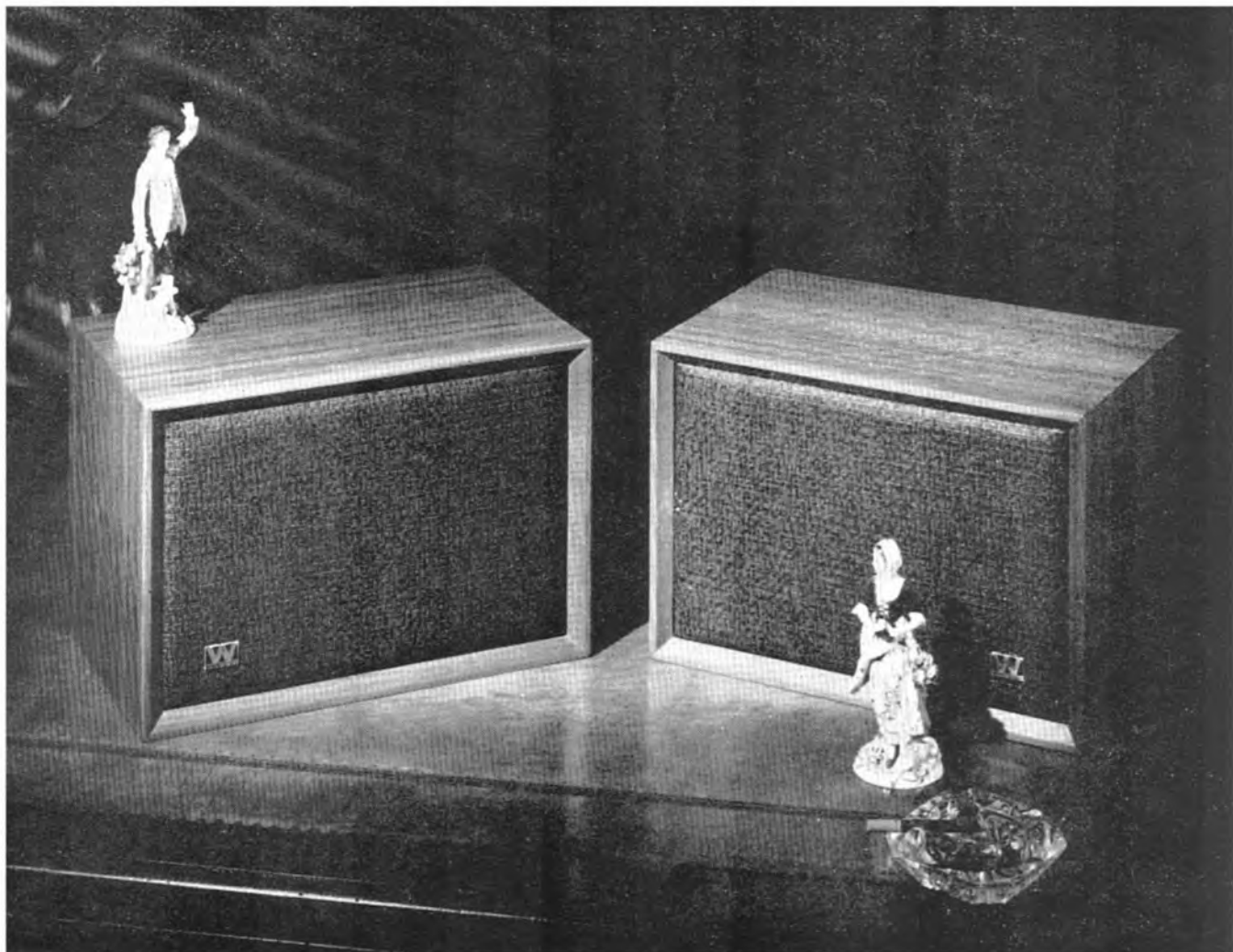

High fidelity stereo starts with Wharfedale **DENTONS** at 30gns. per pair.

The new Denton speaker system brings stereo sound within the reach of everyone. Dentons are excellent operating at less than 10 watts from the existing amplifier in your record player or tape recorder. They are superb when driven by a high fidelity amplifier. Each Denton contains 2 Wharfedale speakers in a beautiful cabinet that is small enough to stand on a bookshelf or mantelpiece. Ask your dealer for a demonstration and prove its superior quality.

- The Dentons are sold in matched pairs for stereo.
- The cabinets are hand veneered and rubbed; each pair made from the same tree — perfect matching of both sound and appearance.
- Each cabinet has two speaker units with a carefully designed cross-over network.
- The dimensions are perfect for mounting on a shelf — so the Denton takes up virtually none of your precious room space.
- Size 9 $\frac{3}{4}$ " high x 14" wide x 8 $\frac{3}{4}$ " deep.
- Response: 65 Hz to 17,000 Hz.
- Finish: Oiled Teak or Polished Walnut.



RANK WHARFEDALE LTD., IDLE, BRADFORD, YORKS.



Vortexion
quality equipment

TYPE C.B.L./7T
TAPE RECORDER

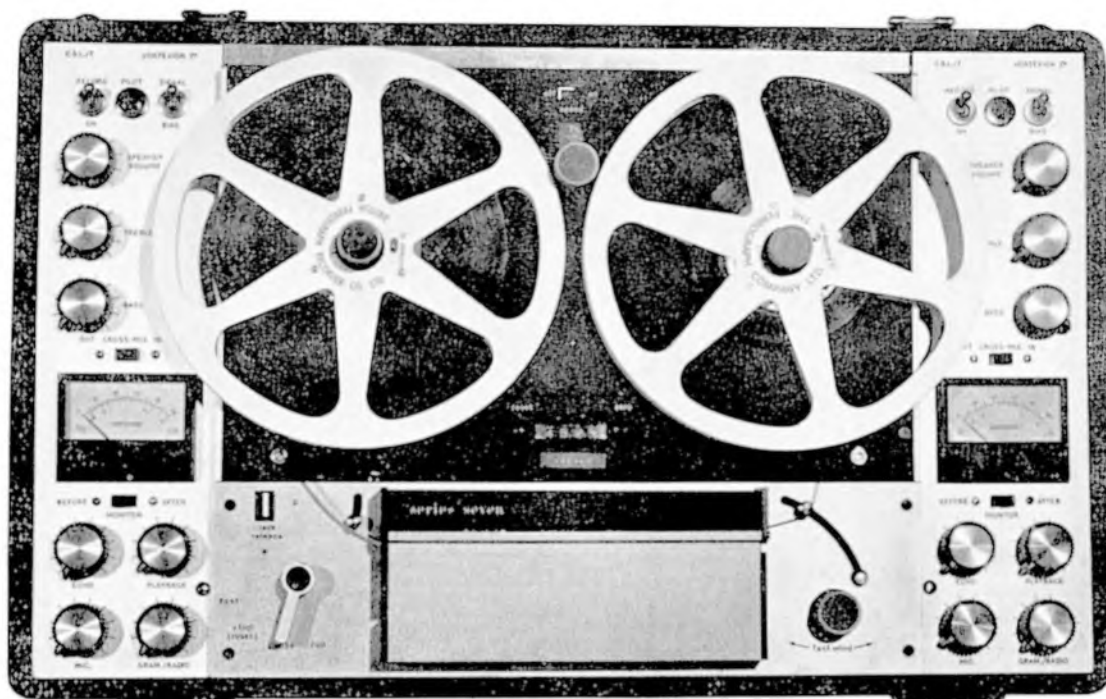

Here is a versatile stereophonic recorder which has no equal in its price group.

The CBL/7T solid state version uses 8 low noise Field Effects Transistors on its twin channel Mic. P.U. and Playback inputs to give low intermodulation distortion, and the 10 watt sine wave 15 watt speech and music amplifiers each have less than 0.05% harmonic distortion and less than 0.1% intermodulation distortion at 10 watts output.

“ Before and After ” monitoring on phones and by internal or external speakers is catered for, and separate power amplifier volume controls allow the speakers to be independently controlled from the headphones. 30/50 Ω balanced line Microphone and P.U. inputs can be mixed with the other channel via a crossmix and an echo control.

All the facilities of the valve model C.B.L. are provided, plus a few extras . . . The series 7 deck has variable speed wind in either direction, solenoid operation, provision for an external switch for remote run or voice operated accessory, and still lower wow and flutter figures.

Mono and full track versions of this will also be available.

AUDIO FAIR
Demonstration Room 334
Booth 2

VORTEXION LIMITED, 257-263 The Broadway, Wimbledon, S.W.19

Telephone: 01-542 2814 & 6242/3/4

Telegrams: “Vortexion London S.W.19”

now hike mike's got company...

...these 5 newcomers to the Audac range of integrated microphone transmitters

Transmitter Type TX/65

for use in highest quality sound systems. Versatile in operation, general purpose use in entertainment industry.



Hike Mike fitted with windshield and 'pop' filter

top quality, all purpose, omni-directional.



High power separate transmitter unit

for professional use where an individual choice of microphone is required. Reliable and trouble-free operation up to 1/4 mile distance.



Transmitter Type TX/45

ideal for the solo entertainer. Uni-directional properties make it most suitable for operation in most difficult acoustic conditions.



Transmitter Type TX/C

Same characteristics as Hike Mike, shape allows either hand or lavalier operation. General purpose.



Like Hike Mike each is completely cordless, contained in one neat unit, no bigger, no heavier than a torch. No following flex, no bulging pocket transmitter

AUDAC RADIO MICROPHONE AND SOUND REINFORCEMENT SYSTEMS

AUDAC MARKETING COMPANY LTD/FOREST WORKS/CAREY RD/
WAREHAM/DORSET/Tel: Wareham 2245

TAPE

RECORDING
MAGAZINE

Incorporating TAPE RECORDING & HI-FI MAGAZINE
and STEREO SOUND MAGAZINE

Vol. 12

No. 5

May 1968

IN THIS ISSUE

Tape trends and tape talk 208
Douglas Brown

Budget Special—AN OPEN LETTER
TO THE CHANCELLOR 209
From the Editor

Techniques—CREATIVE
STEREOPHONY 210
Denys Killick

THE 1968 AUDIO FAIR 216

THE HOME STUDIO 219
John Borwick

Budget Special—WHAT YOU PAY 221

Cross Talk 222
By Audios

Test Bench—VORTEXION CBL/T 223

Book Reviews 225

NATURE NOTES 227
Richard Margoschis

New Products 229

MUSIC ON TAPE—

Musicassette Reviews 231

7½ and 3¾ ips Stereo Reviews 232

Advertisement Inquiries Service 237

FRONT COVER PHOTOGRAPH: You have never seen this tape recorder before, and yet it has something very familiar about its appearance. Yes, it's the first photograph to be published of the new "second generation" Vortexion equipment. Designated CBL/T, it is a fully transistorised version of the existing CBL stereo machines, and it uses the new Series 7 Wright & Weaire deck. The first part of a two-part review appears on Page 223 this month. This is just one of the many original equipments that can be both seen and heard at the Audio Fair.

"TAPE Recording Magazine" is published on the third Wednesday in the month, by Print and Press Services Ltd., from Prestige House, 14/18 Holborn, London, E.C.1.

"TAPE Recording Magazine" is available by a postal subscription of 25s per annum (U.S.A. \$3.75) including postage, or it can be obtained at newsagents, bookstalls and radio and music dealers. In the event of difficulty, write to the Publishers at Prestige House, 14/18 Holborn, London, E.C.1.

Back numbers, if still in print, are available, at 2s. 6d. per copy.

Address all communications

PRESTIGE HOUSE,
14/18 HOLBORN, LONDON, E.C.1

EDITORIAL

01-242 4742

ADVERTISING

01-242 4851

Publisher,
R. DOUGLAS BROWN

Editor,
DENYS G. KILICK

Advertisement Manager, VIVIENNE GOODING

Tape trends and tape talk

By Douglas Brown

THE TAPE OF THE YEAR 1968 is a two and a quarter minute multi-track recording of guitar music by Paul Griffin, a High Wycombe local government officer, who has moved to the top in two jumps—last time his tape “The Breeze and I” took first prize in the “advanced amateur” section of the Contest but missed the premier award.

Mr. Griffin this year took Richard Rogers’ tune “Lover,” made several arrangements of it, played and recorded each in turn, and then mixed them to produce the finished tape. According to his entry form this work of art was composed in his garage last Boxing Day—less than a week before the Contest closing date!

Though the judges were enormously impressed with it—and particularly musician Eric Robinson, who hopes he may find it possible to broadcast the tape in one of his regular radio programmes—it is true to say that the judging panel had some difficulty this year in choosing a Tape of the Year. In most of the contests in which I have participated as an organiser or a judge, I have found that one tape almost always emerges quite easily and naturally as the outstanding entry. It was not so this year. Some considerable time was spent by the judges in reaching their verdict.

Another name in this year’s prize list signals an advance on last year’s achievement. Mr. J. Shuttleworth, a master at Eltham College, London, was second in the “advanced amateur” section last time; this year he carried off the main prize in the Schools class with an interesting tape titled “Page d’Fortune”—a delicate and subtle essay in words and music portraying the conflict between science and the arts.

Peter Bastin, of Worcester, who has also featured in the prize list of a previous Contest, emerged this time as the winner of the Speech and Drama class, with a highly dramatised version of an old legend surrounding Drakesbroughton Hall.

The Documentary class was won by Mr. E. R. Levett with a perfectly straight-forward piece on “Bells and the Art of Ringing”—expository narrative interspersed with recorded examples of country belfries in Devonshire.

The Music section—the most popular category this time—was won by Mr. D. Rivett with a very amusing tape called “Bohemian Picnic” and the Reportage section by the Barrow Sound-track Tape Recording Club with a well-organised four-minute report on an anti-Polaris demonstration called “Protest ’67.”

Mr. Griffin’s “tape of the year” was entered in the Technical Experimental class. There was a new class this time with a set subject—on this occasion “Tape letter to someone abroad.” Mr. D. C. Burton took first place with an untitled four-minute extract from his message tape.

The outstanding stereo tape in the Contest was

judged to be a recording of part of a performance of Belshazzar’s Feast at Nottingham, entered by Philip Towell, of Boston Barrow Sound-track Club took the Club award, with the reportage already referred to.

Special prizes were awarded to two handicapped entrants, Mr. R. Bannister, who is blind and who submitted a multitrack music recording, and Mr. P. Stevenson, a spastic, who sent in part of a tape letter to a friend.

The Contest organisers had had it in mind to award a prize for the most humorous tape in the Contest, but no tapes were felt adequate to merit an award. Humour is, of course, the most difficult achievement to hope for!

I think I can safely say that the judges enjoyed nothing more than a brief “Conversation tape” entered by a proud parent on behalf of seven-year-old Susan Corfield. Her father is an enthusiast. She learned long ago how to operate his recorder. This tape resulted from a spontaneous chat with a friend when there was no one else in the room, but the recorder had been switched on.

Judging of the 1968 Contest was arranged rather differently than in previous years. The preliminary judging and the recommendation of winners in each of the sections was in the hands of the audio journalists who organised this Contest. Their selection of the outstanding tapes was then played to a panel of final judges consisting of Eric Robinson, Basil Boothroyd, Anne Duchene and Christopher Bishop, who then decided the “Tape of the Year.”

Those who would like to hear the winning tapes should contact the Federation of British Tape Recordists and Clubs at the Audio Festival. Presentation of prizes will take place at the Audio Festival on April 20.

* * *

POSTSCRIPT to the Contest report—will Mr. E. Fitzgerald, awarded third prize in the “novice amateurs” section of the previous Contest, please write to me urgently? At the time he won the award he lived in Hawick, Scotland, but he appears to have left that address. In case he does not see this appeal, will anyone knowing his present whereabouts please help?

* * *

IT HAD TO HAPPEN, sooner or later, and the Budget of 1968 looked like being the occasion. But the new one-third purchase tax impost on tape recorders is going to cause some painful indigestion. In particular, the sudden slapping of a 50 per cent luxury tax on tape records is likely to play havoc with that just-getting-established field.

If the national economy is put on its feet again, I am quite confident that the tape recording industry will not be lacking in its effort nor lagging in its achievement.

BUDGET SPECIAL

The Audio Industry is strong enough and resilient enough to bear the burden of tax on domestic equipment. But the Editor has written this outspoken, personal

OPEN LETTER TO THE CHANCELLOR

Mr. Chancellor, Sir,

For you, Sir, I feel deeply sorry. You will be long remembered as the politician who slowly throttled, and then extinguished, a section of British industry. As yours was the Budget, so yours will be the blame. It will be your fault that revenue from exports is lost; it will be your fault that this country is destined to endure such poverty of technical development in this field that we proud British are likely to become the laughing stock of the world.

Not that I believe that you intended such dire consequences. I am happy to give you the benefit of the doubt—you just didn't know what you were doing. But then how could you be expected to understand the complexities of a highly specialised industry? And the professional audio industry, although small, is specialised, just as it is a thriving potential earner of foreign currency. Did I say so? Sorry, I should have said was—was up until the afternoon of Tuesday the 19th of March. With a few words delivered in the space of a few minutes you, Mr. Chancellor, condemned an important section of our audio industry to death. But it will not be a quick, painless, clean death. I forecast three to five years of increasing decadence, creeping like a cancerous growth until it finally overwhelms and subdues its host. After that—nothing. Extinction.

Probably, my dear Sir, you will wonder what on earth I'm raving about. A lunatic, perhaps, with a crazy bee buzzing loudly around an unbalanced bonnet? I can only express the hope that I'm of reasonably sound mind; I can positively avow that I am not a politician. Neither am I arguing a case on behalf of any individual commercial interest. I speak only as an ordinary citizen who, through his job, has some knowledge of the audio industry. Knowledge which you, Sir, in your Budget, have shown yourself to be miserably lacking.

If I am rude I apologise. Presumably it was the task of civil servants to correctly advise you. Permit me then to assure you that they have utterly failed in their duty.

Just what, I wonder, was your intention when you decided to levy purchase tax on tape recorders? Did members of your staff report to you that they had discovered a whole range of domestic appliances that had somehow or other slipped through the meshes of the purchase tax net? And did you, I wonder, reason that since the consumer pays tax on his radio, his gramophone and his television set, it would be only just and reasonable for him to do the same when he buys a tape recorder?

Did you imagine Mr. Jenkins that a tape recorder as defined in Subsection (a) of Group 19A to the Appendix of Notice No. 78T issued by the Commissioners of Customs & Excise and dated March 1968 is nothing more than a small box of electronic marvels that may be purchased off any retailer for upwards of £100 or so? What were your advisers thinking about when they recommended you to exempt only equipment designed specially for scientific or industrial use? Apart, that is, from equipment modified for reproducing speech for the blind.

But what about the people who earn their living by making and using tape recorders that cost not £100 but £1,000, £5,000—even £10,000? These machines are the tools of the audio industry, just as the hammer is the tool of the carpenter, the trowel the bricklayer. With them professionals earn their living. With them the country can earn some of its sorely needed foreign exchange. What have you done to them? Why, you have taxed them at thirty-three and one-third per cent!

If our audio industry were to be as vociferous and noisy as certain other sectors of the industrial front its workers would scream the injustice of your act from the rooftops. There would be demonstrations and marches, strikes and lockouts. As it is the industry is made up of a small number of rather meek, kindly and earnest gentlemen who are dedicated only to their work. And do you know what I think these manufacturers of professional equipment are going to do about it? I think they are just going to sit quietly down and equally quietly die.

Studios cannot possibly afford to pay the tax you have now imposed. Re-equipment programmes will be run down. Equipment will cease to be manufactured. Research will cease; there will be no money to pay for it. Such equipment as is bought will come in from abroad. Up goes unemployment. Down goes the balance of payments. An industry will have decayed in front of our very eyes. And you, Sir, will carry the blame.

The fifty per cent tax imposed on tape records is equally tragic. We are told that the figure of fifty per cent was to "bring them in line with gramophone records." But you haven't done that at all; purchase tax is a percentage of the wholesale value and because that value is very much greater for a tape record than it is for a gramophone record you have imposed more than twice the tax on tape than you will receive when identical programme material is sold on disc.

The market and the industry was small. Probably less than one pre-recorded tape was sold for every hundred gramophone records that passed across the shop counters. But it was an expanding market. Your advisers probably didn't tell you that plans were already well advanced for the establishment of a number of high-speed multiple copying plants to be built in this country. It was hoped that by efficient operation they would bring down the prices of pre-recorded tapes and that they would be able to make products of such quality that they would constitute a valuable addition to our export drive. But that was before the afternoon of Tuesday the 19th March. All that is now left of those enterprising proposals is a pile of useless, abandoned paperwork. Those plants will never exist.

In closing I must reveal my own vested interest in this matter. It is two-fold. Firstly I am interested as a patriotic Briton who refuses to stand by, silent and impotent, as his country is dragged ever lower by inexcusable political bungling. Secondly my obligation on behalf of my readers is to protest vehemently against the wanton destruction of all that has been achieved by an honourable industry throughout the history of its development.

Your foolish action can only result in the lowering of standards throughout the whole of the specialist field of sound reproduction. Whilst the citizens of this country might be prepared to contribute to the Exchequer when they purchase a gramophone record, listen to the radio or use their tape recorder, they are not prepared to accept the degradation of quality that will inevitably result from your apparent determination to deprive the professionals of the tools of their trade.

So I beg you, Sir, to think again on these iniquitous measures which, if they are implemented to the full, will do irreparable harm to our nation. Harm for which you, Sir, must carry personal responsibility.

I remain,

Your obedient servant,

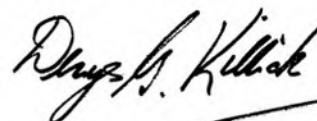

DENYS G. KILLICK (*Editor*).

CREATIVE STEREOPHONY

Tape Recording is an active pursuit with so much more pleasure than can be obtained from mere passive listening. A good live stereo recording is an achievement well worth striving for—and it's not as difficult as you might think.

SO far in this series we have confined our attention to monophonic applications. This was deliberate because basic mono techniques are the cornerstone on which is built the structure of good quality sound recording. The adage "good mono is better than poor stereo" is as true today as ever it was. Faced with such a choice mono wins, or should do, every time.

The choice between good mono and good stereo is equally clear-cut. Stereophonic reproduction scores every time against monophonic sound of comparable quality. And to reproduce stereo it follows that we must first record in stereo.

At the risk of repetition let me again state what stereo is and what it does. If we were to record, say, a symphony orchestra monophonically and then reproduce through a single loudspeaker we will have created an entirely false representation of the original sound. To cover the physical width of the orchestra a number of microphones will probably have been used and these will have been mixed together into our monophonic channel. When such recorded sound is reproduced from a single loudspeaker enclosure the effect is obviously to "squash" the entire sound source (in this case a full orchestra) into the confines of a small wooden box. From this wooden box our mono sound will be radiated into the domestic living room from something that will approximate a "point source of sound." In the concert hall the sound approaches the listener from the full width of the platform on which the instrumentalists are seated; in monophonic reproduction in the home

the width of the platform is contracted into a box that can be measured in inches.

On the other hand there is a very strong argument against introducing that same symphony orchestra into the living room at home. One can hardly imagine a more frightening prospect. And yet this is what stereo would do for us if it were to reproduce with absolute truth. In fact stereophony is invariably a compromise, and its purpose is to convey to the listener a feeling of spaciousness and depth which, although very much better than the false impression rendered by a single loudspeaker, still by its inherent limitations falls short of any attempt to recreate the original performance. And for that limitation most of us will be truly thankful!

The fact is that by merely achieving a spread of sound across the "sound stage" created by placing a pair of loudspeakers a few feet apart the "feeling" of reality is immediately apparent to the listener—a sensation that is utterly missing when listening to single channel mono via one loudspeaker. Visitors to the Audio Fair will have noticed that almost without exception demonstrations are in stereo, not mono. The reason is simple. Even though technical specifications—frequency response, signal-to-noise

ratio, wow and flutter, etc., etc.—may be identical, sound reproduced stereophonically will always appear to be more realistic than its mono equivalent.

Before diving head first into stereophony the dedicated mono enthusiast might well ask what the objections are to reproducing single channel mono but splitting the output between a pair of suitably positioned identical loudspeakers? Surely this would be as good as true stereo? The answer is that, although not as good as genuine stereophonic reproduction, double mono, as it is called, is a vast improvement on single channel mono. Sound will tend to spread around the room in a most satisfying manner but it will lack the degree of reality that is characteristic of good stereo.

So the choice resolves itself into either reproducing mono through a single loudspeaker (which will always lack depth and reality), reproducing mono double via a pair of identical speakers (to give a broad spread of sound and so attempting to simulate the feeling of the original performance) or lastly by reproducing two channel stereo and creating a definite spatial perspective that will endow the musical instruments with apparent solidity and presence in the sound stage between a pair of speakers.

One of the old definitions of high fidelity used to be "the sound that would be heard if one was to be seated in the concert hall." Sorry to be dogmatic, but that statement is in my opinion sheer piffle. Not only do concert halls differ widely in acoustics but the sound heard in any given hall is going to be influenced by the position in the auditorium from which one listens. Quite apart from which if we were to simply shove a pair of microphones in the position that would be occupied by a hypothetical member of the audience we should almost certainly end up with just about the worst recording ever.

When reproducing the sound of an orchestral performance we do not hear what the

Please turn to page 215

THE FINE ART OF MULTI TRACK

As we reported last month our author, F. C. Judd, is indisposed. Readers will join with us in wishing him a speedy recovery, and will be glad to know that he is making rapid progress. He is reported to be enjoying a working convalescence, devoting his time to music and multi-tracking. We look forward to the return of his popular feature next month.

Ferrograph, 1949-1967

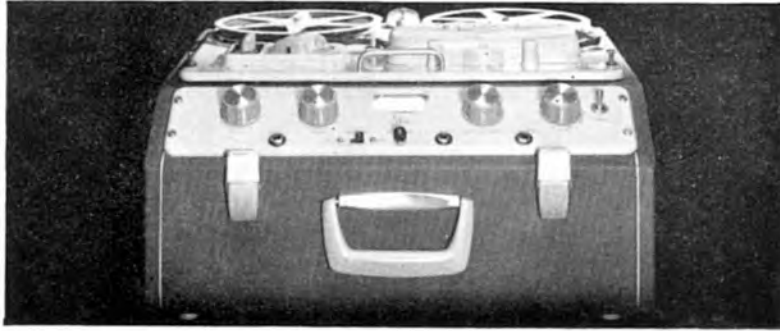

**Now, another major event
in tape-recording and Hi-Fi**

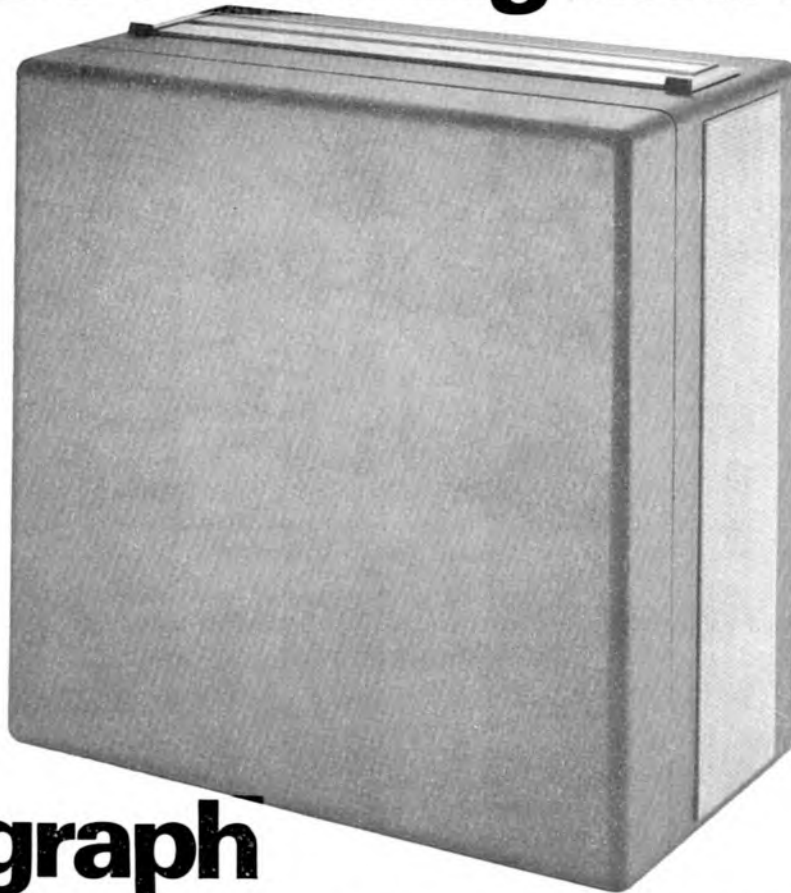

Ferrograph

New Generation Series 7

the tape recorder with the hearing-is-believing sound

Ferrograph quality Ferrograph reliability Ferrograph fidelity plus a unique combination of 30 features

Ferrograph Tape Recorders were the first designed and made in Great Britain—in 1949. Since then they have set the standard of fidelity and unflinching reliability; over the years, Ferrograph have continually improved and added facilities from Series 1 to Series 6, but making no basic changes.

Continuous research and development have now produced a radically new family.

Now, Ferrograph present to you the New Generation, Series 7. Look at its superb new styling, look at its unique range of facilities. As soon as you can, *listen* to it, There is no finer instrument in its class!

To create it, engineers have tested and evaluated every new development. Market research has established what you, the user want by way of facilities—and *all* have been incorporated. Industrial designers have evolved a most appealing presentation and the whole new family is solid state.

Ferrograph New Generation Series 7

This basic Ferrograph instrument is available in Mono, and in Stereo with and without end amplifiers. Each version as a portable, or in elegant hardwood, all with concealed, flush-carrying handles and a new closure design. Every Series 7 instrument is a self-contained chassis-mounted unit, easily fitted into rack or cabinet, easily removed for servicing. Prices from £110.



30 features *Never before* have all these facilities been combined in one tape recorder.

Some you know, many you have so far only wished for:

1. *An entirely new design – with facilities resulting from a study of users' needs gathered over 17 years.*
2. *Modern styling of great functional dignity.*
3. *All silicon solid-state electronics with FET input stages and wide input over-load margins.*
4. *Vertical or horizontal operation.*
5. *Unit construction: The 3 individual units i.e. tape deck, power unit and amplifier complex are mounted on a single frame easily removable from cabinet for service or installation in other cabinets or racks.*
6. *3 motors (no belts).*
7. *3 tape speeds.*
8. *Variable speed spooling control for easy indexing and editing.*
9. *Electrical deck operation allowing pre-setting for time-switch starting without need for machine to be previously powered.*
10. *Provision for instantaneous stop/start by electrical remote control.*
11. *Immediate access head block for editing and cleaning.*
12. *Single lever-knob deck operation with pause position.*
13. *Independent press-to-record button for safety and to permit click-free recordings and insertions.*
14. *Adjustable reel height control.*
15. *Damped tension arms for slur-free starting.*
16. *8¼" reel capacity.*
17. *Endless loop cassette facility.*
18. *Provision for signal operated switching units.*
19. *Internal loud speakers (2) – 1 each channel on stereo, 2 phased on mono.*
20. *4 digit, one-press re-set, gear-driven index counter.*



- 21. 2 inputs per channel with independent mixing (ability to mix 4 inputs into one channel on stereo machine).
- 22. Signal level meter for each channel operative on playback as well as record.
- 23. Tape/Original switching through to output stages.
- 24. Re-record facility on stereo models for multi-play, echo effects etc., without external connections.
- 25. Meters switchable to read 100 kHz bias and erase supply with accessible preset adjustment.
- 26. Three outputs per channel i.e. (1) line out - level response. (2) line out -

- after tone controls. (3) power output - 8-15 ohms.
- 27. Power output 10W per channel.
- 28. Independent tone controls giving full lift and cut to both bass and treble each channel.
- 29. Retractable carrying handle permitting carrying by one or two persons.
- 30. Available in several alternative presentations.

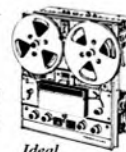

Ideal for rack mounting



Grey vinyl case



Elegant hardwood case

Please see next page for Ferroglyph stockists

FERROGRAPHS

the tape recorder with the hearing-is-believing sound

Listen for yourself

To *know* the Ferrograph New Generation Series 7 you must look at it, listen to it, for yourself. You will find New Generation instruments soon in stock at many of the best tape-recording and Hi-Fi specialists in the country, including the following:

Ferrograph stockists

LONDON AREA

Chiswick
Masseys Centre of Sound
121/123 High Street W4

Holborn
Tape Recorder Centre
82 High Holborn WC1
Larg's of Holborn Ltd
76/77 High Holborn WC1
Imhofs Ltd
New Oxford Street WC1

Paddington
Teletape Ltd
33/59 Edgware Road W2

Richmond
F Cave
27 Hill Street

Streatham
Francis of Streatham
169/170 Streatham High Road SW16

Tooting
REW (Earlsfield) Ltd
266 Upper Tooting Road SW17

Tottenham Court Road
Telesonic Ltd
92 Tottenham Court Road W1

Aberdeen
C Bruce Miller
51 George Street

Banstead
Raylec Ltd
43 Buff Parade High Street

Bath
C Milsom & Son
Northgate

Birkenhead
James McKenzie Ltd
Grange Road West

Birmingham
C H (High Fidelity) Ltd
167/169 Bromsgrove Street 5
Griffin Radio Ltd
94 Bristol Street 5
C H Young Ltd
170 Corporation Street 2

Blackburn
Holdings of Blackburn Ltd
39/41 Mincing Lane

Blackpool
F W Benfell Ltd
17 Cheapside

Bognor Regis
Tansley & Cooke Ltd
Sandymount Avenue

Brighton
Averys
77 St James' Street
Lanes Radio
11 Gardiner Street
John King Films Ltd
East Street

Bristol
Sound Selection
361/363 Gloucester Road 7
Audio Bristol Ltd
Park Street Avenue
Bristol & West Recording
Services Ltd
6 Park Row 1

Bournemouth
Tape Recorder Co (Bournemouth)
Ltd
374 Old Christchurch Road

Cambridge
H S W Speechley & Co
25 High Street Linton

Cardiff
Sound Film Services
27 Charles Street

Cheltenham
University Audio
24 Winchcombe Street

Chester
Lloyd & Wylie Ltd
42 Bridge Street

Chichester
G A Colbourne Ltd
10 Southgate

Crewe
Charlesworth (Crewe) Ltd
14 High Town

Derby
Victor Buckland Ltd
41/49 London Road

Edinburgh
J Nicolson
1 Haddington Place 7

Gerrards Cross
Edric Films Ltd
34/36 Oak End Way

Glasgow
C H Steele
141 St Georges Road C2

Goodmayes
Unique Radio
6 The Facade

Guildford
P J Equipment
3 Onslow Street

Ilford
Ilford Music Shop Ltd
Pioneer Market Ilford Lane

Barking
Davis & Kays
21 London Road

Kirkcaldy
Gairness Brothers
270 High Street

Leeds
Becketts Film Services Ltd
The Headrow 1

P W B Audio Ltd
33 Call Lane

Leicester
United Film Services
7 Kings Street

Liverpool
Beaver Radio Ltd
60 Whitechapel

Manchester
Godleys Radio & TV Ltd
8 Shudehill

Lanes Hi-Fi Ltd
8 Deansgate 3
Kendal Milne Ltd
Deansgate

Newcastle-on-Tyne
Turners Ltd
Pink Lane

Nottingham
Audio Centre
Pelham Street

Oxford
Westwoods
45 George Street

Plymouth
A E Ford Ltd
84 Cornwall Street

Redcar
McKenna & Brown Ltd
135 High Street

Salford
Stephens
348 Gt Cheetham Street East 7

Sheffield
Sheffield Photo Co Ltd
6 Norfolk Row Fargate

Southampton
University Audio
4 Bargate Street

Southport
Wayfarers Radio Ltd
Burton Arcade

Teddington
Daytronics Ltd
119a High Street

Torquay
D & B Davies Ltd
Casle Chambers Union Street

Watford
EME (Watford) Ltd
188 Queens Road

Worthing
Bowers & Wilkins Ltd
1 Beckett Buildings Littlehampton Road

FERROGRAPH

the tape recorder with the hearing-is-believing sound



If none of these is near enough to you, in case of difficulty, or for free literature, send us the coupon, or give us a ring on WATerloo 1981.

To The Ferrograph Co Ltd
Ferrograph House
84 Blackfriars Road London SE1
Please send me a free brochure on the
Ferrograph New Generation Series 7

NAME

ADDRESS

.....

.....

.....

TRM

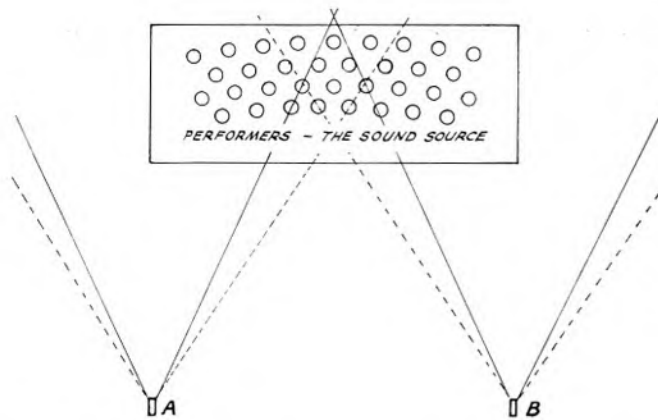

Fig. 1. Positioning microphones for recording stereo. If two directional microphones, A and B, are placed as shown the recording is bound to have a "hole-in-the-middle". Turning each microphone inwards will cure the trouble but will reverse the sides of the sound stage covered by each instrument. See text.

CREATIVE STEREOPHONY

Continued from page 210

audience would have heard, but a distinctive blend of instrumental tones created for us by the recording engineer. So when recording—particularly when recording stereo—forget all about "what the listener would have heard if . . ." and concentrate on creating something new; an individualistic representation rather than a slavish carbon copy.

Microphone arrangements for stereophonic recording can be very simple or they might be highly complex. As in mono applications the fewer microphones that can be used the better. So the simplest and very often the best microphone arrangement for stereophony is to use just two mikes, one for each channel.

In explaining the differences between mono and stereo I used the symphony orchestra for illustration. In fact, the amateur is far more likely to be working with either very much smaller instrumental groups, with choirs, church organs or similar sound sources. Unless the work being performed is of unusual character or the performers are placed in difficult positions such subjects are usually ideal for the simple two microphone technique.

Because we are endowing our recording with directional qualities the use of appropriate directionally sensitive microphones is desirable. My own choice would be for good quality moving coil cardioids. As good cardioid microphones tend to be relatively expensive I would make do with a pair of reasonably priced ribbons as next best. Cheap ribbons are usually very much better than cheap moving coils in terms of overall sound quality, but one has to remember the live rear face that will pick up both room resonance and extraneous (audience if one is present) noise.

The precise positioning of the two microphones relative to each other and the sound source will depend upon a number of factors—room acoustics, performer positions, etc.—but the positions chosen will positively influence the directional information recorded. The biggest mistake is to produce a recording which, when reproduced, will be so directional as to have what is known as the "hole in the middle" effect. By this we mean that apparently unrelated sound issues from each of the two speakers in a stereophonic pair and no sound at all appears to originate from the space between them.

A microphone arrangement as shown in Figure 1 will produce recordings of this character. Our pair of microphones, A and B, have been placed opposite to the two outside wings of the sound source. The un-

broken lines indicate the angle of acceptance for the maximum signal and flatness of response, the broken lines indicate an area of quality and sensitivity reduction that becomes more marked as the angle is widened. Coverage of the centre of the sound source is so poor that the hole in the middle would be sure to result, accentuated by the

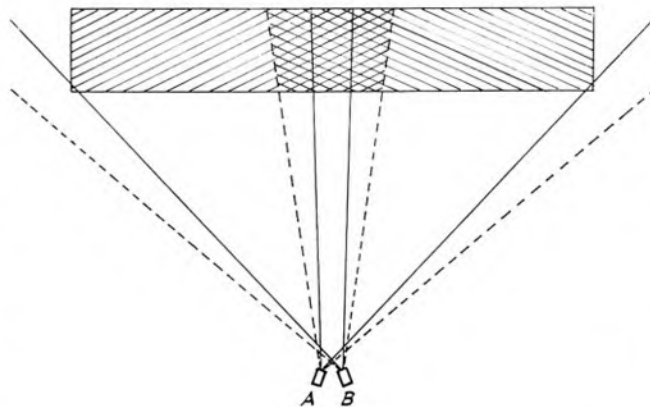

Fig. 2. A conventional stereo arrangement giving a good, solid, central sound and adequate directional information from the two sides. The two microphones, A and B, are close together centrally, angled towards the opposite "halves" of the sound stage so that the left-hand microphone (A) picks up from the right, the other, (B) from the left.

extra prominence given to sounds originating at the extreme edges.

If microphone A were to be turned half-right and microphone B half-left, this would produce an immediate improvement, but if the actual width of the sound source were to be great enough there would still be some danger of losing central sounds. Although some experts might consider this suggested arrangement to be very bad I have found it to be highly successful when the distance between the two edges of the sound source is no more than six or seven feet. For a choir numbering about thirty it will give a delightful illusion of spaciousness in reproduction. Particularly note, however, that inclining the two microphones in the manner suggested results in changing the relative sides of the sound stage covered. Microphone B will be covering the left hand side and microphone A the right.

An alternative arrangement, usually more successful for larger groups of performers, would be to move the two microphones to within an inch or two of each other to a central position. They would still be angled half-left and half-right, but this time their acceptance angles cross each other within inches of the microphone heads instead of at a point near the front of the sound stage. This new arrangement will be less positively directional than the first but will give a good spread of sound between a pair of

stereo speakers. This is the arrangement I would adopt for an organ recording where the sound stage is often an extended row of pipes. Working under reverberant conditions such as exist in most churches the reflected sound will tend to obscure direction; nevertheless some extremely fine recordings can be made in this way.

Balancing up a pair of stereo microphones mounted centrally is very easy. Get someone to stand precisely on the dead-centre line about a couple of feet from the two microphone heads and from that spot get him to speak (Mary had a Little Lamb!) looking dead ahead. In the monitoring room play with the levels on the two channels. As the two channels are faded up and down the sound of the voice will appear to move from side to side. Adjust levels so that the voice is dead central. Although I do not like "cans" for monitoring there is no doubt that they do assist in fixing a positive stereo balance which can sometimes be masked by room acoustics if one is relying on loudspeakers. When listening over cans in this way it is quite uncanny how the image appears to move from side to side within one's own head—you will find you can even point to a spot on your forehead and say it is exactly here!

Having fixed as near a perfect balance between the two channels as is possible it is essential that the same relationship between them should be maintained during the progress of recording. If one channel should be altered without the other then the aural effect will be to apparently move the position of the sound source within the sound stage. Taken to illogical absurdity it is quite a simple matter to achieve a recording in which sections of the choir or orchestra apparently slide back and forth effortlessly from one loudspeaker to the other. Needless to say this is thoroughly bad recording technique.

Recording live stereo is not difficult. Because of the enhanced quality and impression of reality it will give it is far more satisfying than working mono. For best results the two microphones *should* be identical; they *must* be in phase. When positioning microphones do not hesitate to place your eye at the rear of the instrument and squint along its length as if you were sighting a gun. In this way you can be sure of covering the correct area.

Never be put off by people who try to tell you that recording stereo is difficult. A little more complex than mono, yes, but that is all. But the results can be so much better that for all music recordings I have given up mono entirely. If you have a stereo machine available together with a couple of microphones why not start to experiment?

The International Audio Festival and Fair has been described as—

THE 1968 INTERNATIONAL AUDIO FESTIVAL & FAIR

“The biggest, the best, the most important show of its kind in Europe.”

Do not miss seeing and hearing these—and other— attractive exhibits

MORE than ninety firms will be showing their products at the Russell Hotel, London during the period of the 1968 International Audio Festival and Fair from Thursday the 18th April to Sunday the 21st April. Last month we published a full list of exhibitors together with their booth and demonstration room numbers. Now we can take a quick look at some of the more interesting products that will be on show.

From the masses of literature put around by the various firms describing their exhibits it is only too obvious that there will be more than usual to interest readers this year. But of all the new items there can be no doubt that the greatest immediate interest will centre around the completely new Series 7 *Ferrograph* decks and complete recorders. *Ferrograph* are to be found at booth 53 and demonstration rooms 133 and 134. Technical details relating to this new equipment are given in our New Products section this month on page 229. The equipment will be available for demonstration and explanation at the Russell Hotel for the very first time.

The new Wright and Weaire deck will also be featured in a new generation of *Vortexion* equipment (booth 2 demonstration room 334). The first part of a two-part review of the stereo machine CBL/T appears on page 223 of this issue.

In demonstration room 317 *Agfa Gevaert* will be copying from high quality master recordings on to small spools of Agfa tape for the benefit of visitors. *Audio Design Limited* (room 356) will be demonstrating a new high quality British cartridge known as the Induced Field Cartridge. Also in room number 314 demonstrations of their professional record cleaning machine will be given to the trade only. Sennheiser microphones are being demonstrated by *Audio Engineering Limited* in room 355 by reproducing original stereo recordings made under domestic conditions. Comparisons will be made between different types of microphones and staff will be available to answer questions.

In room number 149 a new colour film “The Timeless Track” will be screened by *BASF Limited* and tickets will be available from booth 55.

A new four-speed Uher tape recorder, the Royal de luxe, will be featured in room 361 by *Bosch*. This advanced stereo machine has all the usual modern features together with optional two or four track heads. In addition to their usual products *Jordan Watts* will display two new models in their range of high fidelity loudspeakers. These are the Janet and the Juliet, both small bookshelf units. Demonstrations will be in room number 448.

Brenell Engineering Limited (booth 89 demonstration room 242) will be showing and demonstrating the Brenell Mark 5 Series 3 equipment together with the well-known Hi-Fi Tape Link. A new model BSR turntable, the UA75, will be released at the Fair for the first time. This together with other BSR products will be demonstrated in room 259.

Cosmocord Limited (booth 77 room 217) are featuring the Acos GP 91 SC stereo compatible cartridge, a new and improved version of the cartridge first shown in 1967. In room 302 we can see the famous *EMI BTR4* studio recorder in both stereo and mono versions and also three versions of the L4 battery portable. The *EMI* matched loudspeaker sets launched last year will also be shown together with audio recording tape and accessories.

Engineers and constructors will find much to interest them at booth 76 and demonstration room 261 where *Ferranti* will be exhibiting and demonstrating audio equipment using silicon planar transistors.

Denham & Morley Limited are handling three different manufacturers' products: On stand 31 and demonstration room 256 *Radionette*, on stand 33 and demonstration room 255 *Oki* stereo tape recorders and on stand 41 MB Electronic microphones and headsets.

A completely new range of Braun hi-fi equipment will be shown by *Fi-Cord International* on booth 57 and in room 253 and the same company will be showing Beyer microphones on booth 58 and in rooms 215 and 254.

New record playing units by *Garrard* will be found in room 234, in particular the model AP75 which is said to offer



Revealed for the first time, the *Ferrograph* Series 7.

high quality at moderate cost. *Grundig (G.B.) Limited*, booth 69, demonstration room 634, are exhibiting their full range of hi-fi equipment and tape recorders including a number of interesting new models. *C. E. Hammond & Co. Limited*, the distributors of *Revox*, will be showing the new Series 77 stereo tape recorders at booth 19 and in demonstration room 663. A new loudspeaker by *KEF Electronics Limited*, the *Concerto*, can be seen and heard in room 542.

H. J. Leak Limited (booth 54, demonstration room 104) will be showing their new “Stereo 70” transistorised integrated amplifier (see New Products page 230) together with other equipment. In room 347 the *3-M Company* will demonstrate the complete range of Scotch audio magnetic tapes on professional recording equipment and will also show a wide range of accessories.

The distributors of Sanyo tape recorders (*Marubini-Iida Co. Limited* booth 73, demonstration room 342) hope to have certain new products in time for the Fair but details are not yet available. The existing range of Sanyo equipment will of course be on show.

Demonstrations of Trio equipment by the distributors *B. H. Morris & Co. (Radio) Limited* take place in room 260. These will include the Trio TK-60 BE

THE 1968 INTERNATIONAL AUDIO FESTIVAL & FAIR

“The biggest, the best, the most important show of its kind in Europe.”

solid state automatic AM-FM multiplex stereo tuner amplifier, a new model. The emphasis on video recording is underlined by the introduction of a new Model 21 video half-inch tape splicer kit by the Bib Division of *Multicore Solders Limited* who will be exhibiting this and their wide range of useful accessories at booth 62.

A full display of *Philips* equipment may be seen in room 337 and demonstrations will take place in adjacent rooms. Highlight is the new tape recorder designated PRO12 designed for industrial and professional studio applications, a twin track stereo machine operating at two speeds $3\frac{3}{4}$ and $7\frac{1}{2}$ ips the approximate price is quoted as 180 guineas.

AKG microphones will be shown by *Politechna (London) Limited* at booth 88 and in demonstration room 237. The popularity of the “two-way system” used in the D202 microphone is now extended to the D200 a lower cost version and the D224 which in a higher price bracket is aimed mainly at professional users. A number of other interesting instruments will be on show for the first time including moving coil headsets which will be available for visitors’ use at a “listening bar.”

Amongst the Akai products shown by *Pullin Photographic* at booth 8 and in demonstration room 563 will be the Model

3000D, a deck with pre-amps., Model X150D and Model M-9 which replaces Model M-8. Also on show will be the 1710W, X-IV, X-300 and X-355 plus the Akai speakers.

Microphones by *Reslosound* are at booth 15 and in demonstration room 348. Amongst the new models is the MPD2 a miniature omni-directional instrument. The latest improved form of the UD1 together with a range of public address amplifiers, loudspeakers, microphone stands and boom arms will be displayed. *Rogers Developments Limited* (booth 48 demonstration room 602) are showing an important addition to their range, the Ravensbourne “2” FET FM receiver. The Ravensbourne “Compact” speaker system will be demonstrated for the first time at the Fair. Latest development from *Tannoy* is the “Monitor Gold” unit which will be demonstrated in its 15 in. and 12 in. versions and also as the III LZ Monitor Gold at booth 67 and in room 547. Technical staff will be available to advise on the selection of loudspeakers and enclosures.

Sansui audio equipment will be found at booth 28 and in demonstration room 159, where a number of new units can be seen for the first time. *Truvox Limited* (booth 94 demonstration room 636) confine themselves to stating that they have an important product announcement to make at the Fair and they anticipate that it will arouse a good deal of interest. Visitors will be able to see for themselves and will doubtless be able to hear any new products demonstrated. *Whiteley Electrical Radio Co. Limited* are not only showing the well-known WB Stentorian high-fidelity loudspeaker units but also the new Stereo 30 integrated amplifier and loudspeaker systems including ready-to-assemble cabinets. These items will be found at booth number 85 and in demonstration room 304 where members of the staff will be happy to discuss visitors technical problems.

The Telefunken range of equipment includes tape recorders, amplifiers, speakers and transcription units, all of which will be displayed by *A.E.G. (Great Britain) Ltd.* on booth 47 and in demonstration room 247. The *Ampex* exhibit of

pre-recorded tapes and high-class recording equipment can be found on booth 5 and in demonstration room 536.

Professional equipment is always of great interest to amateurs, and the products of *Elcom (Northampton) Ltd.* are on show at booth 78 and in demonstration room 249.

Elstone Electronics Ltd. have two displays. At booth 26 and in demonstration room 540 can be seen—and heard—the Miniconic Cartridge by the Euphonics Corporation. New models in the Tandberg range are at booth 24 and in room 504. Loudspeakers by *Lowther Manufacturing Co.* always attract a great deal of attention; go to room 204 or booth 1.

Microphones are delightful instruments to handle and to use. The *Lustraphone* range, including their latest models are located at booth 79 and in demonstration room 145. *Metro-Sound Sales Ltd.* are responsible for three displays: Sonotone at booth 49 and in room 154, Ortofon in room 647 and at booth 51 and Thorens booth 50.

Loudspeakers by *Wharfedale* (booth 87, demonstration room 502) will include the new Super Linton, and their System 20 amplifier, tuner and transcription unit will also be featured. Another loudspeaker manufacturer, *Richard Allan Radio Ltd.*, (sorry we spelt the name incorrectly last month) will be showing Richard Allan “hi-fi modules” and complete enclosures. They don’t say whether the “speaker in a honey tin” will appear again this year.

These are but a few of the displays and demonstrations that may be enjoyed by the visitor during the period of the Fair.

Lastly we would remind you that members of the staff of *TAPE Recording Magazine* will be available in room 343 where they hope to renew contacts with old friends and make new ones. We will again use a system of appointments to enable readers to contact individual members of the staff who will do their best to be available at certain fixed times. Please do sign our visitors book and please do make your personal comments about the Fair, about *TAPE Recording Magazine* or audio topics in general in the space provided.

UHER

the ONLY tape recorder for YOU...

4000 REPORT SERIES Three different models of the Uher 'Report' are now available:

4000 Report - L

As illustrated. Specification: 2 Tracks conforming to international standards-2; Tape reels diam.-5"; Tape speeds (ips) $\frac{1}{2}$, $1\frac{1}{2}$, $3\frac{1}{2}$, $7\frac{1}{2}$; Frequency range (cps) 40-4, 500/40-10,000 and 40-16,000/40-20,000; Dynamic volume range (db) 40 at $\frac{1}{2}$ ips, 46 at $1\frac{1}{2}$ ips, 50 at $3\frac{1}{2}$ ips, 52 at $7\frac{1}{2}$ ips; Wow and flutter (max \pm %) 0.2% at $7\frac{1}{2}$ ips; Recording mono; half-track; playback mono half-track; Power output one watt.

Monitoring via headphones or speaker; VU meter + three digit tape counter; tape stop-start remote control, collectorless motor controlled by 8 transistors; power supply from 6V, 12V, 24V car battery, from rechargeable accumulator or 5 flashlight cells 1.5 Volt; 17 transistors.

Microphone, radio, pick up input: 1V at 15 Kohms and 2V at 4ohms. Weight 6 lbs (approx). 121 gns.

4200 Report Stereo

Affording all the advantages of the successful 4000 Report-L in size, style and specifications—plus stereo. 146 gns.

4400 Report Stereo

Again with all the advantages of the 4000 Report-L—plus stereo and maximum economy of tape on four tracks without deterioration of reproduction quality. 146 gns.



724 L Stereo

Specification: 4 Tracks conforming to international standards-4; Tape reels diam.-7" Tape speeds (ips) $3\frac{1}{2}$, $7\frac{1}{2}$; Frequency range (cps) 40-14,000, 40-18,000; Dynamic volume range (db) 45 at $3\frac{1}{2}$ ips, 46 at $7\frac{1}{2}$ ips; Wow and flutter (max \pm %) $3\frac{1}{2}$ ips 0.2, $7\frac{1}{2}$ ips 0.15. Recording mono and stereo; Playback mono and stereo; Power output. 2 x 2 watts; Microphone, radio, pick up inputs, output 1V at 15 Kohms and 2.8V at 4ohms. Weight, 20 lbs (approx.) 97 gns.

DISTRIBUTED IN U.K. BY

BOSCH

The range of UHER tape recorders and accessories available in the U.K. satisfy the requirements of every amateur and professional enthusiast.

...when quality is your first concern

... always ask for UHER tape recorders and accessories. Quality is the simple, single aim behind their manufacture. Their production is also the sole pre-occupation of the UHER Company, whose specialisation has led to many outstanding developments, including the first application of printed-circuit techniques in tape recorder manufacture. For further details contact BOSCH LIMITED, UHER Division, Rhodes Way, Radlett Road, Watford, Herts. Telephone Watford 44233.

BOSCH

has established a universal reputation for quality backed by continuous research, development and over 80 years of manufacturing experience. 85,000 BOSCH employees are universally engaged in the research, manufacture, distribution and service of BOSCH products. These include an impressive range of domestic appliances; radios; stereograms; tape recording equipment; automotive accessories and safety equipment; electric tools; hydraulics; language laboratory and closed circuit television systems... all of which are marketed in the U.K. by BOSCH LIMITED... a member of the BOSCH GROUP.

THE HOME STUDIO

FROM JOHN BORWICK

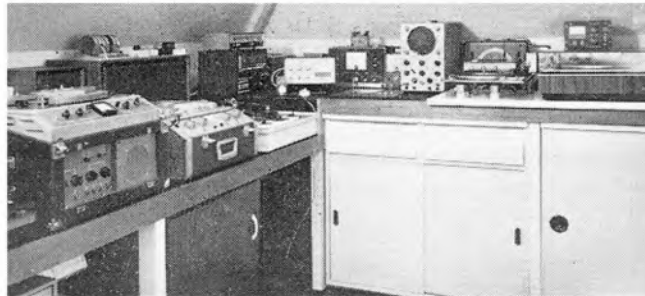

A corner of John Borwick's home studio, showing E.M.I. TR-52 and Ferrograph 631 recorders, Quad 33/303 amplifier, Garrard 301 and Sony turntables, SME 3012 pick-up arm, Shure V-15 II cartridge, Goodman's Magnum-K loudspeakers etc., etc.

SO far we have dealt mainly with the mechanics of the home studio; now we can turn to the operating drill. Sticking to established procedures is a good insurance policy for making consistently polished and tidy recordings. It is one of the main features that distinguish professional tapes from most amateur ones.

I know that the home studio must be able to work to a crash programme; often the recording has to be fitted in between conflicting family activities, or the people you are taping have to catch their last bus home. But this won't always be the case, and, if you have worked out a good drill, you will be better able to perform rush jobs too.

Preliminaries

Allow time for mains operated equipment to warm up at least 5 to 10 minutes. You can speed up the warming time for recorders by fast winding them, with no spools on the spindles, and similarly set your gramophone turntable(s) running. This warming up process is particularly necessary if the equipment has been in a cold room.

If you think this warm-up time is a bore, I must remind you of some of the numerous preliminary activities that can be going on at the same time. You can be cleaning the tape heads and possibly de-magnetising them. Clean all volume controls or faders that you will be using—a few swishes up and down should be enough to clear any noisy patches on carbon or wire-wound controls. The stud variety can be dosed with cleaning fluid.

Check that you have enough tape of the right grade for the job in hand. This will pre-suppose that you have an accurate

knowledge of the durations to be recorded. Try to time any rehearsals—or get the “performers” to do this for you. I suppose it is a counsel of perfection to use virgin tape for every recording: but try to approach this ideal as near as you can. Use new tape for the more important “master” recordings and “reclaimed” tape for the others. Do you operate a tape reclaiming cycle? Briefly, this means going through your used tapes at intervals, cutting out any damaged portions, passages to be kept in your library and unwanted leader tapes. You can splice the good tape together (without mixing different grades) and spool it on to sound, unwarped reels. These should then be completely erased (by running through in the “record” condition with the input faded down, or by a bulk eraser) put in neat boxes, with new titling labels, and added to the stock for recording purposes.

During your preliminary time checking, remember that the advent of tape has eliminated the need for continuous recording. Except where musicians, actors or interviewers insist on a non-stop performance, you can often recommend recording in chunks—to be edited together later—and this may simplify the problem of calculating the tape lengths required. You can suggest convenient stopping places in the performance or even record certain sections out of sequence if some participants or materials are only available for part of the session.

Make sure that everybody involved knows the procedure being followed. Check the cueing system to be used. Check the recording level on rehearsed samples of each constituent part of the

recording—instruments, voices, sound effects, etc. Finally check your monitoring levels and that the signals are actually going on to tape. If your recorder has no off-tape monitoring facility, you will have to make a short trial recording and wind back to check that it is O.K.

If you do have the set-up which permits switching your loudspeaker or headphones between the incoming signal and the recorded signal, then the merest AB comparison will confirm whether all is well. For myself, I feel this off-tape monitoring—throughout the recording, on meter at least and loudspeaker if possible—is essential. Some recorders can be modified for the purpose by fitting a separate replay head, pre-amplifier and appropriate switching.

Dubbing and Transferring

The preliminaries over, let's look at the drill for recording from tape, disc or radio—the operations we referred to last month as dubbing and transferring. Here, unlike “live” recordings via microphone(s), we at least have the possibility of accurate timing, setting of levels, etc.

With the tapes ready threaded on Machines A and B, for replay and record respectively, we simply want a starting and stopping procedure that will produce a perfect copy of the recorded passage, without clicks or an audible creep up to speed. Machine B can be set running ahead, of course, and any unwanted gap cut off later. But the tapes on Machine A must be set back sufficiently for its speed to reach full by the time the first required note or word reaches the replay head. This allowance may be as much as 2 seconds, or

Please turn to page 221

Is it possible for all
these features to be concentrated
in ONE tape recorder?



Yes, the BEOCORD
has them all!

- Built-in 4-channel mixer section with twin slide potentiometres
- Records on 2 tracks. Plays back on 2 and 4 tracks.
- Trick recordings: Multiplay, sound-on-sound, synchro playback, echo
- Usable as microphone-amplifier during tape replay
- 3 tape speeds
- 2 illuminated recording level indicators
- Tape control lever
- 4 Bogen heads
- Monitoring
- Instant pause control
- Slack absorbers
- External impedance switches
- 3 replaceable pre-amplifiers
- DIN standard inputs and outputs
- Input and output sockets on base of cabinet
- 2 separate 8-watt output amplifiers
- Automatic stop for tapebreak and end of tape
- Sockets for two pairs of speakers
- Amplifier can be used with motor switched off
- Separate bass and treble controls
- Headphonejack
- Low-impedance microphone input, balanced
- Line input and output, (tape-copying channel)
- Tape index counter
- Voltage switch
- Fully transistorized

A highly advanced tape recorder with professional wow and flutter specifications, crystal clear reproduction, and ample volume output, the Beocord 2000 de Luxe is designed for the exacting audiophile who insists on unlimited possibilities in trick and sound-on-sound recordings etc. The Beocord 2000 de Luxe ranks among the five highest priced semiprofessional tape recorders in the world. It ought to be the highest priced of them all!



- for those who
consider design and quality
before price

Bang & Olufsen
U.K. Sales Division
Eastbrook Road
Gloucester

London Showrooms
70/71 Welbeck Street
London W1

Solomon & Peres
67/69 Ann Street
Belfast 1

HOME STUDIO continued from page 219 somewhat less on recorders which possess a "pause" control.

As for the setting of the volume controls, I prefer to have Machine A already open at the setting that proved best at rehearsal and Machine B turned down. Then, when both machines have been switched to run, I fade up Machine B. This should give a clean start with no clicks or unwanted material on Tape B. If the copy is to start at full volume, this fading up must be completed by the time the required passage begins—and a yellow mark on Tape A might be useful for cueing purposes. If a slow fade-in is required, I should *begin* to turn the control at the cue and make an artistic fade as rehearsed.

So the drill becomes as follows:—

1. Start Machine B
2. Start Machine A
3. Fade up Machine B either immediately to the rehearsed setting or gradually to produce the required fade in.

At the end of the dubbing, a similar drill is used:—

1. Fade out Machine B, either quickly or gradually.
2. Switch off Machine B.
3. Switch off Machine A.

If Machine B has a pause control and I want to follow with another dubbing or live recording, I use the pause button instead of switching off, and I ease the tape back an inch or two by hand so that I re-record over any noise impressed on the tape by the acts of arresting the tape and switching off Machine A.

Now I hope that no grandmothers reading this will think I am trying to teach them to suck eggs. I am the first to admit that this drill thing is just a question of common sense. But I have been jerked out of my chair by so many amateur tapes with loud plops at the beginning and end (and in the middle) or with scruffy or non-existent fades that I have made bold to spell out the procedure here.

How about tape speeds? Many people like to save time during dubbing, and emulate the high speed tape copying techniques used to produce commercial tape records, by running Machines A and B at double or quadruple speed. Well, there is no objection to this provided you have tried the effect with these same two machines before and been satisfied with the sound quality. There is bound to be some loss of treble but you may decide, in simple speech recordings for example, that this does not matter.

Take the case where Tape A was originally recorded at 3 $\frac{3}{4}$ ips. and you want to halve the dubbing time by running the machines at 7 $\frac{1}{2}$ ips. (to produce a copy tape that will re-run at 3 $\frac{3}{4}$ ips.). Of course each frequency recorded on Tape A will be doubled. So a recorded frequency range of 50-10,000 Hz, for example, will

be fed to Machine B at 100-20,000 Hz. If Machine B cuts off at about 15,000 Hz, you will lose some top—though some machines will allow you to introduce pre-emphasis—via the tone controls or by switching the equalisation to the 3 $\frac{3}{4}$ ips. setting although you are running at 7 $\frac{1}{2}$ ips. The great thing is to establish the best settings for any such operation so that you can undertake it confidently at short notice. It is also possible to save time by dubbing more than one track at a time, for example with a pair of half-track stereo machines having separate mono programmes on Tracks 1 and 2. Don't worry that you may be dubbing one of the tracks backwards. In fact there is a theory that the quality is better when you dub in this way.

I think I have said enough on the tape-to-tape drill to indicate the right procedures for recording from disc or radio. Strive for neat beginning and ends and try to achieve the recording level that just avoids over-modulation on the loudest passages.

Microphone Drill

Live recordings need a slightly different procedure. Now you have to alert the performers, start the machine, fade up the gain and cue the performers. If the performers must be in the same room as the recorder (not recommended) then you can simply give them hand cues and monitor on headphones (or not at all).

If you have installed the recorder in a separate room, you have the advantage of proper monitoring and the slight disadvantage of needing to arrange some system of cueing. A talk-back system is ideal—the recordist can call out instructions via a separate microphone relayed through to a small loudspeaker in the "studio." There is a risk of howl-round since the studio microphone will pick up these instructions, reproduce them over the monitoring loudspeaker, on to the talk-back microphone and so on. This can be avoided by using headphones in the studio or arranging that operation of the talk-back switch simultaneously cuts the monitoring loudspeaker.

For less ambitious cueing, it is a simple matter to have a battery operated lamp in the studio connected by bell-wire to a button alongside the recorder. Alternatively, you can get one of the performers to cue the recordist by saying "Stand by: we're starting in 5 seconds from now." This will give time to fade down the gain, start the machine and fade up as rehearsed. It should also ensure a quiet start, since the studio will presumably keep silent during these 5 seconds and start cleanly. Impress on them too that a similar 5 seconds of silence at the end of the recording will help.

Next month I shall go into more detail on equipment and techniques for monitor-

BUDGET SPECIAL

WHAT YOU PAY

WE have held this column open until the last minute before going to press so that we can bring you the very latest news of how the new Purchase Tax levies are going to affect you personally. Unfortunately the situation is still confused and the trade is still trying to establish rulings on what is to be taxed and at what rate.

At first glance the new regulations seem to be simple enough. The wording of the official directive issued by the Commissioners of Customs and Excise is as follows:

(a) *Instruments, whether or not complete, which are, or if complete would be, suitable for the reproduction of sound recorded on magnetic tapes or other recording material, whether or not those instruments are, or if complete would be, suitable also for recording sound, and parts thereof and accessories thereto, liable to purchase tax at 33 $\frac{1}{3}$ per cent.*

(b) *Sound records on magnetic tape or on other recording material, other than records of a kind not produced in quantity for general sale, liable to purchase tax at 50 per cent.*

(c) *Containers (not comprised in any other Group) for records falling within paragraph (b) above, liable to Purchase Tax at 50 per cent.*

Not Chargeable under the above headings are:

(1) *Tape recorders and reproducers suitable only for scientific or industrial use, and parts and accessories suitable only for use therewith.*

(2) *Instruments suitable only as office appliances for the recording or reproduction of speech, and parts and accessories suitable only for use therewith.*

Examples given of goods chargeable include: *Magnetic tape recorders, reproducers and cassette players; other types of magnetic recorders and reproducers; erasers, demagnetisers and depolarisers; special cleaning tools; identifiable parts and accessories for use with magnetic tape and other recorders; splicers; pre-recordings on magnetic tape and other material (but unrecorded tape is not chargeable); cabinets for tape and other magnetic records, cassettes, carrying and storage cases.*

There is a specific exemption for *sound records for the reproduction of speech, specially adapted for the use of the blind; and instruments specially designed for the reproduction of sound from such records.*

So much for the official information. There are many anomalies. At the moment of going to press it looks as if we may have to pay tax on the spool and the box, but not the tape itself, when we buy a reel of unrecorded tape. This is not certain and is still under discussion. If a tape recorder is sold complete with a microphone then the microphone will be liable to tax—if the microphone is sold separately, not as "an identifiable accessory" then it will not carry tax. In the future we are bound to find that microphones will rarely be included in the purchase price of a tape recorder. We might also find that the "free" spool of tape normally given with a new machine also vanishes.

As the situation becomes more clear we will keep readers advised on the latest developments.

TUESDAY, the 19th March, 1968, will long be remembered by the tape recorder and music on tape industries. For the first time in history their products have been subjected to purchase tax.

One can hardly quarrel with the imposition of tax in principle. If it is wrong to tax tape recorders then it must be equally wrong to tax a wide and miscellaneous range of other products. There never has been any really valid argument to support the continued exemption from purchase tax that tape recorders have enjoyed for so many years.

Agreement in principle however does not imply agreement with the level at which purchase tax has now been imposed. However bad we may consider the 33½ per cent tax on tape recorders we cannot consider the addition of 50 per cent to the prices of pre-recorded tapes—including musicassettes—to be anything other than a most wicked and iniquitous act that will benefit no one. The simple minds of our bureaucratic masters had obviously decided to bring music on tape in line with gramophone records; since the existing tax on a gramophone record at 27½ per cent was to be raised to 50 per cent then tax on tape records should also be 50 per cent. The lunacy of this gross over-simplification is incredible. Consider the relative positions of the gramophone record and the 4-track 7½ ips stereo tape. A long-playing classical gramophone record costing 38s. has had its price increased to 42s. 9d. The increase a mere 4s. 9d. Now if that same programme material is sold on tape it would have cost 75s. The reason for the difference in cost is of course due to the relatively more expensive manufacturing processes involved. So now with the new purchase tax our 75s. tape will cost in the region of £5 3s. of which approximately 28s. is tax.

Before the budget the price difference between the same programme material sold as a gramophone record or a tape record was the difference between 38s. and 75s., that is 37s. Now the difference will be between 42s. 9d. for the disc and £5 3s. for the tape, that is about 60s.

And what does all this achieve? A revenue so tiny that it must be quite inconsequential, to be raised at the expense of the stultification of a new and promising industry that had every prospect of earning large sums of foreign currency in the export market. And the music-lover is penalised because he wishes occasionally to listen to a pre-recorded tape of his choice.

Purchase tax on tape recorders must obviously be borne and can be accepted as an evil necessity against which we can hardly protest. The tax on pre-recorded tapes is an act of abject folly

CROSS TALK

By Audios

which I can only imagine to originate from a determination to prevent the citizen from indulging in private pleasure however innocent. This vicious tax must be attacked at every opportunity until it is either abolished entirely or at least reduced to a level compatible with our principles of fair play and basic humanity.

* * *

THE arrival of the second generation Ferrograph equipment heralds what we might regard as the dawn of a new epoch. Whilst other manufacturers flitted gaily from design to design the good old Wright & Weaire deck went on quietly turning and turning and turning. Its passing will be mourned by many.

The kind of enviable reputation that the original equipment earned is not acquired overnight. The new Wright & Weaire deck will have to prove itself as worthy of its antecedents. I have no doubt that the manufacturers have made every effort to build into their new equipment the same rugged reliability for which the previous models were famous. I cannot imagine that the older style decks will rapidly depreciate in value—in fact they might even acquire an enhanced value by their scarcity.

All of us hope that the new deck will be as least as successful as its predecessor; in particular we look forward to it opening up even wider markets overseas. As for me, I am not in the least disturbed by the fact that I have bought two Series 6 decks for my own use within the last twelve or eighteen months. I shall get from them what I bought them for—long and faithful service. And that in the long run, is what really counts.

* * *

WHEN will they ever learn? Time and again I get people asking me for advice in the purchase of a radiogram. What can I tell them other than, "Don't do it. Please, don't do it."

After all the publicity in specialist and national press, after all the demonstrations, audio fairs and exhibitions it is amazing to find that people still think in terms of radiograms.

The radiogram was an invention of the thirties; it had outgrown its usefulness within thirty years. And yet in this affluent society of artificial obsolescence and desperate keeping-up-with-the-Joneses people still go out and buy radiograms.

At the conclusion of the Consumer Association analysis of radiograms published in their magazine *Which* it categorically stated that if

roughly the same amount of money that was to be spent on a radiogram were to be invested in separate items of free-standing hi-fi equipment then the purchaser would get very much better value in terms of sound quality. This value is increased by the ability to change any single item in a hi-fi network without scrapping the lot, and also by avoiding having to find floor space for the ghastly great coffin-like box into which so many radiograms are built.

So if anyone else wants to talk to me about buying a radiogram—please don't. Save money improve quality and increase enjoyment by going "hi-fi," and if the thought should scare you to death then why not investigate the secondhand market? A quick glance down the equipment for sale columns proved to me that I could have acquired a really excellent outfit for around £100; new value nearer £300. The radiogram that could stand up against that quality just hasn't been made.

* * *

MY recent notes speculating on the uses to which stereo tape recorders are put has prompted Stanley White, United Kingdom representative of Concert Recording, to write to me. He sympathises with the problem and feels sure that most serious recording enthusiasts would much prefer to undertake live recording rather than merely reproduce commercial tapes.

As an encouragement to amateurs he generously offers to audition amateur stereo recordings of church organs with a view to considering the issue of the material as a commercial stereo tape record. Recordings should be made at a tape speed of not less than 7½ ips (15 ips is acceptable) and low noise tape should be used. The recording should be half-track, but if 4-track should be recorded one side only to permit editing. Recordings of cinema pipe organs cannot be included in this offer for technical reasons but Mr. White will be only too pleased to learn of recordings of church organs without vocal accompaniment.

For safety's sake do not send original tapes but a 7½ ips copy. It would also be necessary to submit written proof of permission for the recording to be taken and used commercially from both the organist and organ-owner. A proper payment will be made for any material actually used.

A final word of advice from Stanley White is to suggest that any amateur recordist working with music which is still in copyright is strongly advised to write to the MCPS whom he describes as "not the monsters some people would have us believe and who will do all they can to help to solve any musical problem—not try to stop recording as some would make believe is their aim in life." That very wise advice and timely pat on the back for MCPS will I hope be heeded. Readers who are interested should contact Mr. Stanley White at PO Box No. 2, Rothwell, Kettering, Northants. There is obviously an opening here. Why not take advantage of it?

* * *

PREOCCUPATION with the tax gatherers this month has reminded me of an appropriate comment taken from the Disney film "Jungle Book." One of a pair of gaunt-looking vultures turns to his companion and says, "Things look dead, don't they?"

"Ah!" replies his companion mournfully, "I wish they were. . . .!"

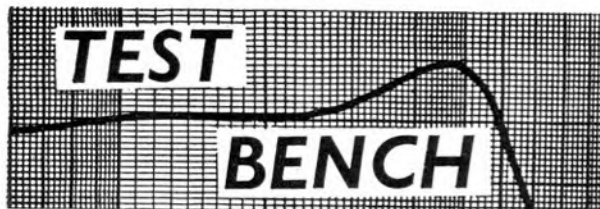

PART ONE OF A TWO-PART REVIEW

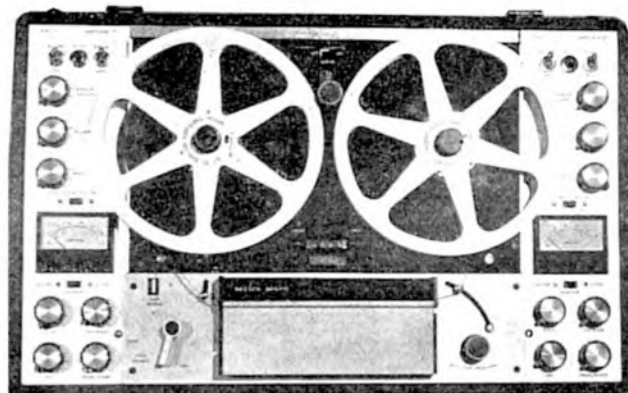

VORTEXION CBL/T

Part One BY DENYS KILLICK

THE release of advance information describing the new Wright and Weaire tape transport system is obviously of the very greatest significance. As reported in our New Products section this month (page 229) the new deck will be incorporated in the "second generation" Ferrograph tape recorders designated Series 7. It will also be used in a completely new generation of Vortexion equipment.

Usual practice in our Test Bench series of equipment reviews is to put the equipment through a complex series of technical and practical investigations over a period of many weeks. We were however most anxious to bring you news of this dramatic new British equipment just as soon as possible, and so now through the courtesy of Vortexion Limited of Wimbledon we are able to describe to you an examination of the prototype of their new CBL/T machine which incorporates the Wright and Weaire Series 7 deck.

It must, however, be made quite clear that this is not a comprehensive investigation. Since the machine is a prototype and not a production model it would have been grossly misleading to publish technical findings—apart from which the machine examined could not leave the possession of the manufacturers; as the very first prototype it was the only model available.* In view of these complications this review cannot do more than describe the functioning of the equipment and quote details of both facilities offered and the manufacturer's *intended* specification. As such it may be regarded as the first part of a two-part review; as soon as production models are readily available we will carry

*At time of writing, Mid-March

out our usual technical investigation, and publish a complete table of results. It is hoped that readers will bear with us and will appreciate that this procedure has been adopted to enable us to offer as much information as possible at the very earliest moment.

In general layout the new Vortexion CBL/T follows the basic arrangement that has proved so successful and popular in previous CBL models. Enclosed within a sturdy black carrying case the deck itself is positioned centrally with the electronics and control panels repeated on either side, the left-hand module for the left-hand channel and the right-hand for the right. There are many advantages in adopting this approach, not least is the complete separation of the mechanical and electronic sections, which with the provision of adequate ventilation ensures cool running. As with previous models in the Vortexion range the new equipment may be safely operated with the lid closed, and as will be seen from the illustration the casing has been so designed that 8½ in. spools can be accommodated without overhang.

The CBL/T is a complete stereophonic record/playback mechanism with a claimed 10 watts RMS per channel output available at a pair of external speaker jacks. Advanced transistorised circuitry has been used and the manufacturer claims that the distortion level of the main output amplifiers is less than 0.05 per cent (less than 0.1 per cent inter-modulation achieved through the use of eight FETs). Since these figures relate to the connection of 15 ohm speakers the amplifiers would be rated somewhat higher when working into 8 ohm loads. As is usual with transistorised amplifiers the output transformers have been dispensed with altogether, but special steps have been taken to protect the final stages against open circuit or short circuit; these conditions will not cause damage.

An unusually wide range of facilities is provided via the two identical control panels. As the deck may be operated in either the

horizontal or vertical positions we will in our description assume that the recorder is standing upright as shown in the accompanying illustration.

All four recording controls are grouped logically together beneath the unusually large and very easy-to-read peak programme meters. They comprise, at the bottom of each panel, a pair of level controls, one for 30/50 ohm balanced line microphone input and the other for gram/radio or any other preamplified sound sources. These two inputs may be mixed. The third of these four controls is labelled "echo." This mixes the signal from the separate playback head into the record amplifier and so enables reverberation at any desired level (or time-constant dependent upon tape speed) to be added whilst a recording is actually being made without the need for any external connections or equipment.

This feature was not included in previous CBL models and could be most useful. The presence of the control on the main panel, however, could lead to trouble since it would be easy to accidentally turn the knob and so produce unintended reverberation which would completely spoil a "straight" recording. The more facilities that are provided the more care must be exercised in using them.

The fourth rotary control of this group, marked "playback," governs the level to the line-out socket (which may be used for headphone monitoring) and is either a before or after record signal according to the position of the slide switch immediately above. The meter itself has been specially designed for the equipment and is calibrated with two scales, the upper an arbitrary 0-100 for use when adjusting bias levels and the lower in decibels with the usual zero peak position.

Immediately above the meter is another slide switch marked "cross-mix" which enables either the left-hand channel output to be mixed into the record amplifier on the right-hand channel or vice versa. Continuing up the control panel we have the usual three main amplifier controls, volume at the top followed by treble and bass. The volume controls govern the audio output at the two built-

(Continued overleaf)

in speakers—arranged one on each side of the case to give left-hand and right-hand channels—and also the output at the external speaker jacks which, when operative, mute the internal speakers.

Another interesting and most useful departure in the CBL/T is the linking of the main output amplifiers to the before/after monitor switch. The signal heard at any outlet on this machine will be either that fed into the record amplifier or will be the playback from the head, dependent entirely upon the position of the slide switch. This means that for practical recording applications the operator will only need a pair of good quality, full range, loudspeakers (either 8 or 15 ohm im-

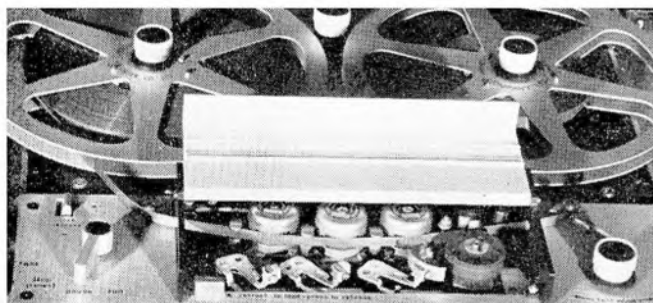

The head cover hinged back reveals the sound channel with the pressure pad control lever at the left front. The inscription reads: "retract to load—press to release". As can be seen, the pads are brought well back for tape loading.

pedance) and these together with the machine will form a complete, self-contained recording and monitoring unit. For less exacting requirements one could even rely upon the internal speakers, provided quality and balancing assessments are not critical.

At the top of the panel we have a pair of ordinary toggle switches with a red neon pilot light centred between them. The switch on the right enables the meter to monitor incoming signals when thrown into the signal position and to read bias levels when thrown the other way. Bias can be adjusted by means of a pair of rotary controls mounted on a recessed rear panel. The left-hand toggle switch is "record on/off" which overrides the main record key located in the centre of the main deck plate. It has been included so that either channel may be switched into, or out of, the record mode independently, thus increasing the versatility of the machine by allowing simultaneous recording on one channel with playback on the other together with complete cross-fading and mixing as required. The warning pilot light positively indicates when a channel has been properly set into the record mode, which, of course, requires the main record key to have been depressed and the switch to be in its "on" position. Tape erasure will only occur when the pilot is glowing.

All connections in and out are by standard jack socket; recessed panels are provided at each side of the case for microphone in (tip ring and sleeve balanced line) and line out. External speaker sockets are at the rear, mounted on a panel which also contains the mains 3-pin socket, erase and motor links, variable bias controls, voltage selector and a remote control socket. The whole offers a most pleasing and workmanlike appearance and both the size and the weight will be rather less than that of a Series 6 mono machine. Those who have suffered from the bulk and weight of the Series 6 CBL recorder—a machine that has so very nearly broken your reviewer's back on innumerable occasions—will be overjoyed to learn of the more practical portability of this transistorised version. For that alone the manufacturers will earn the heart-felt thanks of countless recording enthusiasts.

Now we come to a description of the deck. Let me first state that this is basically extremely simple and efficient in operation. However, since many of its controls are highly individualistic, some attempt must be made to explain them in detail. If this explanation sounds involved then the fault is mine, not the manufacturer's. However difficult I may inadvertently make its operation appear to be this is merely due to the difficulty of expressing simple motions in equally simple words.

Firstly this is a three-speed, three-motor mechanism, solenoid controlled throughout and embodying a variable speed fast wind facility. Since the deck may be used in either

the horizontal or vertical positions some means had to be provided for keeping the spools in place and this is done by means of screw-on hub retaining caps. The deck was used successfully in the horizontal position without these retaining caps in place but they are essential for upright use. To lace the tape the large aluminium head cover is first hinged back to reveal the three heads, the pressure pad assemblies, tape guides and capstan and pinchwheel. A pressure pad control is located on the left; it is indicated by an arrow together with the wording "retract to load—press to release." When this small lever is pulled towards the operator the three arms carrying the pressure pads pivot right back about an inch and a half or more away from the heads, leaving a completely clear path for the tape. The two sides of the head cover assembly are fixed and each carries a slot. The slot in the right is vertical and is aligned with the capstan; on the left an offset vertical slot (positioned much further forward) opens into a lateral slot. With the tape held taut between the two hands it is merely dropped into the two vertical slots and will then automatically take up its correct position. This is a great improvement on all previous methods of loading tape into Wright and Weaire decks.

If the operator next hinges the head cover back into its closed position it will be found that it engages automatically on to the specially shaped surface of the pressure pad lever and so brings the pads back to their operating position of their own accord. Alternatively this control may be operated manually with the head cover open.

It was found in practice that if one attempts to use the equipment with the heads exposed it is only too easy to forget to return the pressure pads to normal before starting to run. This is not a criticism because we found this mechanism to be highly efficient and thoroughly practical—it just takes a little getting used to. The tape is led to the take-up spool via an anti-slur tension lever which also serves as the automatic stop (Note. This automatic stop only functions in the run mode not in fast wind.)

Tape transport modes are controlled by a rotary lever switch of substantial proportions

to the left of the sound channel. This has four positions marked "fast," "stop (reset)," "pause" and "run." To the right of the head assembly is another rotary control, "fast wind," with arrows indicating left-hand and right-hand direction.

When mains power is applied a tiny amber pilot light in the centre of the main deck plate is illuminated. If the function switch is now turned to the "fast" position both the speed and direction of the tape movement is controlled by the fast wind knob on the right. When the engaged reference mark is positioned centrally the tape is stationary. When turned to the right the tape will be wound on to the take-up spool; slowly if the knob is only rotated a little way, very fast if turned to the maximum of its right-hand rotation. To stop from fast wind one might either again rotate the speed and direction knob on the right to bring it back to its neutral central position, which of course will result in first slowing down the tape and then bringing it to a halt, or alternatively the function switch on the left can be brought into its stop position. If the latter operation is carried out then when next turned to "fast" the tape will immediately begin to move in the direction and at the speed indicated by the setting of the right-hand direction control knob. On the other hand if the tape had been brought to a halt by means of that control it would still be necessary to bring the function control out of "fast" into the "stop (reset)" position before going on to any other function.

When tape is fast winding it was noted that the pressure pads are held well away from the heads and the tape is free to run clear of the head surfaces. The combined variable speed and direction is something of a novelty, but like the other aspects of this mechanism investigated was found to be a thoroughly practical and useful facility. If the control is rotated from maximum speed right-hand travel to maximum speed left hand travel the tape merely slows down, stops and then picks up speed in the opposite direction. At no time did it appear to be subjected to excessive strain. During the all too brief time the machine was available to us we found this system to work with delightful ease and simplicity. It was also noted that the tape was wound far more evenly and more tightly than was the case with earlier Wright and Weaire decks.

When the function control comes out of the "fast" position it travels naturally to "stop (reset)." From this point a safety lock device (visible in the illustration and marked "lock release") comes into operation. This prevents accidental movement into either the "pause" or "run" modes and must be released before the function control will turn further. In the "pause" position the machine is really in "stand-by" condition with the capstan motor turning, pressure pads closed and in fact all systems go apart from drive being applied to the tape from capstan and pinch wheel. Continuing on round into the "run" position brings the pressure wheel and capstan into contact, applies the drive to the tape and the spools revolve. Switching has been so arranged that the capstan and pinch-wheel cannot remain in contact when the capstan is stationary.

The clock type position counter of previous models has now been superseded by a four-digit numeric system. This is mounted on a panel centrally in the main deck plate with the large red record key immediately beneath the line of figures. Set zero for the counter is the usual push button on the right but to the left is a brilliant red neon marked "reset." This pilot light gives an unmistakable warning if the operator through his use of the function control, has achieved a "lock-

out" which is immediately remedied by merely turning to the "stop (reset)" position. A very simple precaution that ensures that the proper functions have been correctly aligned.

At the top centre of the deck is located the mains on/off switch and the speed change control. Both high speed and low speed versions will be available, high speed giving 15, 7½ and 3½ ips, and low speed 7½, 3½ and 1½ ips. The speed change itself consists of a heavy knurled knob which when rotated displays the relevant operating speed through an open window.

We do know for a fact that a great deal of time, care and attention has been devoted to the design of this deck. Unfortunately it was not possible to examine it mechanically but we are assured that attention to detail has been meticulous. For instance, the capstan spindle is provided with a double gimbal mounting to ensure absolute concentricity which will enormously improve wow and flutter figures. It is confidently anticipated that these will be comfortably below 0.1 per cent RMS at 7½ ips and at 15 ips we should be able to record a reading around 0.05 per cent RMS. These figures will be subject to confirmation as soon as we have an opportunity of carrying out our own technical tests. Physical damping must be excellent because the entire mechanism was remarkably free from both vibration and noise when in the run mode. In fact the only mechanical sound to which we could raise the slightest objection was heard when the rewind motor was straining on a heavy spool of tape at slow winding speed. Under this condition it did emit a noise reminiscent of the Mark 6 deck in similar circumstances. Our overall impression of the deck was of a remarkably fine piece of engineering, well designed and well presented; in fact a deck that stands every chance of fulfilling the high hopes that all of us have for it.

Turning now to the operation of the complete unit we have already explained why it is not possible to include detailed technical measurements at this stage. We can however quote the manufacturer's aims and also describe our subjective opinion from such brief user tests as could be carried out.

Personally I think it is a great pity that people tend to look first to frequency response; I would pay far more attention to signal-to-noise and distortion. If these figures are good then any reasonable frequency response will result in what is colloquially known as "a cracking recording." Signal-to-noise figures quoted by the manufacturer (he hasn't even been able to measure them himself yet!) are around the minus 50 to minus 55 dB level. This is vitally important, and if a level of about minus 55 dB could be finally achieved then we shall really have something quite outstanding.

However it must be remembered that signal-to-noise is related intimately to record distortion levels. The more distortion that is accepted the higher will be the peak level and so the better will be the signal-to-noise ratio. With the CBL/T—which after all is a professional equipment—it is proposed to offer two datum points, the first marking the 1 per cent distortion line and the second 2 per cent. As the usual domestic standard is 3 per cent (some machines even go to 5 per cent) it will be appreciated why we comment that signal-to-noise ratio of minus 55dB would be outstanding if it is achieved at these low distortion contents.

Anticipated frequency response is in the order of 20-18,000 Hertz plus or minus 2dB at 7½ ips, and 20-12,000 Hertz plus or minus 2 dB at 3½ ips. We would expect 15 ips.

operation to extend this scale upwards a little. These figures are remarkable since they extend downwards well below the generally accepted minimum level of human hearing and this has been achieved by the very original Vortexion circuitry employed. Knowing only too well the general attitude of this manufacturer to his specifications one may rely implicitly upon the equipment doing at least what he says it will—the only surprise would be if its actual performance did not exceed published figures. Sticking out my neck I would hazard a shrewd guess that not only will these figures be substantiated but we shall find that the tolerance of plus or minus 2 per cent is more than adequate and the upper limit will usefully extend to at least 20,000 Hertz, even at 7½ ips. However the proof of that particular pudding will be in the eating and we shall be delighted to offer unbiased technical findings in the second part of this review just as soon as the opportunity presents itself.

Another important feature of the CBL/T is that the equalisation characteristic may be either to CCIR or to NAB to order, or in fact may be changed by the manufacturer to any time constant that might be required by the customer. Machines delivered from stock will be CCIR unless specifically ordered to another characteristic.

Short tests demonstrated the value and flexibility of the electronics. Recordings of known quality immediately displayed a new brilliance and clarity of tone when reproduced on the CBL/T, the output of which was fed to a pair of full range speakers. Although lacking the means to substantiate the manufacturer's exceptionally low distortion figures for the output amplifiers it was quite obvious that we were listening to something quite remarkable. And with that short test we unhappily had to leave this brilliant new machine, which by the way, is still undergoing minor modifications. Even whilst writing this review the manufacturers have told us that it has been decided to incorporate "single plug" stereo monitoring at the line output sockets by fitting tip ring and sleeve jacks which will give a single channel if an ordinary two-pin jack is inserted or stereo if a three-pin jack is used. Production models will differ from the photograph because the main control panel plates will be engraved with reference numbers around the rotating controls; it has also been made clear that the peak programme meters may be used to visually monitor the output to the line out socket but not to the main amplifier since this is independently controlled with its own volume setting.

Lastly the remote control facility (socket mounted on the rear recessed panel) merely requires a suitable plug and means of shorting the lead for operation. It has even been worked with an ordinary bell push. The function control remains in the "pause" position for remote control use.

So there we come to the end of our description of the Vortexion CBL/T. We feel quite justified in publishing this divorced from technical investigation in view of the great public interest in this new British equipment. Part two of this review, which will include all our usual data, will appear just as soon as a production model is available. Before concluding we must make it quite clear that the manufacturers have emphasised that their new transistorised recorders will be confined to the complete stereo model described above and a single monophonic model fitted with three heads and offering before and after record monitoring. They do not regard the new equipment as in any way superseding the existing Series 6 machines

which will continue to be available in all the various versions (including the CBL Series 6) to provide equipment for those who prefer valves to transistors. Production of the two new models should start in time for supplies to reach the retailers towards the end of May.

Prices to be announced

D. G. K.

T.R.M.

BOOK REVIEWS

FUN WITH TAPE. A Focal Sound Book.
By Joachim G. Staab. The Focal Press, 21s.

In the 250 pages of this paperback the author really does give sensible and practical advice on recording applications. The title, *Fun With Tape*, led me to expect a somewhat childish publication. I now know just how wrong I was.

Although originally written in German the English translation by Vernon Gorter is excellent. The text has obviously been heavily edited to suit the British reader; a couple of paragraphs are even devoted to elocution and pronunciation. This is one of the few books intended for amateur recordists that actually offers advice on how to read a script, how to choose suitable material for recorded drama and even how to adapt the novel to the requirements of the dramatic sound script.

This excellent book is just packed with suggestions for the creative use of recording equipment. It is not exhaustive—it cannot be because the subject is inexhaustible. But if anyone feels they have "nothing to record" then *Fun With Tape* will offer dozens and dozens of answers.

SOUND AND VISION. By Peter E. M. Sharp. A Design Centre publication, published by MacDonald & Co. (Publishers) Limited, 7s. 6d.

This volume is one of a paperback series covering equipment for leisure pursuits and has as its companion issue *Boats for Sailing* by Ian Proctor. The series already includes eight books containing detailed information on various aspects of domestic interior design and on the selection of suitable furnishings and household equipment.

The scope of *Sound and Vision* could hardly be broader, embracing as it does both television and audio. Audio covers turntables, pick-ups, preamplifiers, etc., etc., and notes are included on records and recordings and even on hiring, maintenance agreements, guarantees and service facilities.

Over-simplification it bound to be the failing of such a comprehensive work; on the other hand its intention is to introduce the subject of sound and vision to those who have no previous knowledge. As such the information, although basic, is accurate. The usefulness of a publication which illustrates Leak and Quad amplifiers on one page, Bush and H.M.V. portable record players on another and then leads on into television rental is bound to be limited. The novice is probably better served by acquiring a single book devoted to the one aspect of sound or vision which really interests him rather than by skating so lightly over the surface of all associated subjects.

FRANCIS OF STREATHAM

EVERYTHING ADVERTISED IN STOCK

MAINS RECORDERS

AMPEX 753 professional Stereo Deck and Pre-amp. Transistorised, 3 speed, 4 Track. (Mics. extra.) **91**
A special from Francis. gns.

Ampex 800 Series Stereo
Ampex 1100 Stereo
Ampex 2100 Stereo
*Akai 1710 Stereo
*Akai X-300 Stereo
*Akai 910 Mono
*Akai M.8 Stereo
*Akai 355 Stereo
*Beocord 2000 de luxe Stereo
*Beocord 1500 de luxe Stereo
*Brenell STB2 Stereo
*Brenell Mk.5/M Series III M.
*Brenell Mk.5 Series III Mono
*Ferrograph 633 Prof. Mono
Ferguson 3230 Mono
Ferguson 3224 Mono
Ferguson 3232 Stereo 4 Tr.
*Ferrograph 631 Mono 2 Track
*Ferrograph 632/4 Stereo
Fidelity Playtime 2 or 4 Tr. M.
*Grundig TK245 S/M pre-amp
*Grundig TK340 Stereo
Grundig TK140 4 Tr. M 3 1/2
Grundig TK120 2 Tr. M 3 1/2
Grundig TK145 Auto 4 Tr. M
Philips Cassette 3312 Stereo
Philips 3310 Cassette Mono
Philips 3575 St. 3 sp. 4 Track
Philips 3576 M 4 Track 3 sp.
Philips 4306 2 sp. 4 Tr. Auto M.
Philips 4305 4 Tr. 2 sp. Mono
*Philips 4408 Pro. 3 sp. 4 tr. St.
*Revox 736 2/4 Tr. 2 sp. Stereo
*Revox 77 Stereo Transistor

Sanyo 929 4 Tr. 2 sp. St.
Sanyo 939 4 Tr. 2 sp. St.
*Sanyo 999 3 sp. 4 Tr. St.
(Speakers extra)
*Sanyo 800 3 sp. 4 Tr. St.
PA/Deck
Stella 462 Mono 4 Tr. 4 sp.
Stella 463 Mono 4 Tr. 2 speed
Stella Mains/Batt. Cassette
*Tandberg Ser. 6X St. PA & DK
*Tandberg Ser. 12 St. 3 sp. 2/4 Tr.
*Tandberg Ser. 8 St. 2 sp. 2/4 Tr.
*Tandberg Ser. 9 M 3 sp. 2/4 Tr.
Telefunken 200 Mono
*Telefunken 204 St. 4 Tr. 2 Sp.
Telefunken 203 Ser. 50 M2/4 Tr.
Telefunken 201 Mono 4 Track
Truvox 50 Series M 3 sp.
Truvox R102 or R104 Mono
*Truvox PD102 or PD104 St.
*Uher Hi-Fi Spec. St. PA/DK
2 speed 4 Track
*Uher Royal St. 4 sp. 4 Tr.
Ultra 6212 Mono 4 Tr. 3 sp.
*Vortexion WVA 3 sp. 2 Tr. M.
*Vortexion WVB 3 sp. 2 Tr. M.
*Vortexion CBL 3 sp. 2 Tr. St.
*Windsor Vanguard 3 sp. 4 Tr. M

BATTERY MODELS

Akai X-IV 4 Tr. Stereo
Loewe Opta 416 2 Tr. 2 sp. B/M
Loewe Opta 450 Cassette B/M
Philips EL3302 Cassette
Philips 4200
Sharp Batt./Mains 2 Tr. 2 sp. M
Sony TC 800 2 Tr. 2 sp. M. B/M
Stella 473 Cassette
Telefunken 300 2 Tr. Mono
Telefunken 302 4 Tr. 2 sp. M
Uher 4000L 4 Tr. 2 sp. Mono
*Uher 4200/4400 2 sp. St.
*Microphones extra

FOR A FAIR DEAL AND HONEST SERVICE

- ★ Minimum Deposit and no Interest or Service Charges on H.P. up to 18 months.
- ★ Free Service during Guaranteed Period.

SPECIAL TAPE OFFER

Brand new Shamrock Tape.
Top quality. Guaranteed.
2,400; 7" spool ... 25/-
1,800; 7" ... 21/-
1,200 7" or 5 1/2" or 5" ... 15/-
900; 5" ... 12/6
600; 5" ... 10/-
P/P 1/6 per reel. Orders for £3 or more sent post free.

MICROPHONES, MIXERS

Hammond Condenser M100
Grampian Reflector
Grampian DP/4 Dynamic
Reslo Ribbon
AKG D.19C
Eagle Mixer
Hammond 5-way Mixer
AKG K.50 Headphones
Philips Pre-amp
Microphones by ACOS, TELEFUNKEN, BEYER, FILM INDUSTRIES, also STANDS, BOOMS, etc.

MAINS POWER PACKS

Philips, Stella or Cossor
Telefunken 300 with cell
Uher 4000, with cell
PRE-RECORDED TAPES & CASSETTES by Columbia, H.M.V. and E.M.I. Bib and E.M.I. splicers. Matching transformers. Deflexers, etc., etc.

Hi-Fi Dept.

- **AMPLIFIERS**
Quad Rogers Leak Armstrong
Tripleton Scott Truvox Nikko
Goodman Ferguson Philips
Arena Sinclair Tandberg
"Huldra"
- **TUNERS**
Quad Rogers Philips Leak
Armstrong Tripletone Arena
Nikko Arena Tandberg
"Huldra"
- **LOUDSPEAKERS**
Quad Rogers W.B. Kef
Wharfedale Goodman Tannoy
Lowther Leak Elac Truvox
Ditton Philips
- **MOTORS, PICKUPS**
Garrard incl. Thorens
SP.25 401, etc. Tannoy
Goldring Shure
Connoisseur Empire
Decca Sonotone
Decca Deram SME Mk. II
Philips BSR
Ortofon Pickering
Dual Euphonic
All types of Diamond and Sapphire styli, stereo and mono, Microlifts, Garrard, Goldring and Acos Pressure Gauges, Disc Preener, Acos Dust Bug.
- **CABINETS** by Record Housing Clearview and G.K.D.

169-173 STREATHAM HIGH ROAD, LONDON, S.W.16

Between St. Leonard's Church and Streatham Station

01-769 0466/0192

Please note this is our only address ● Free Car Park in Prentis Rd.—2 mins. away
OPEN ALL DAY SATURDAY—EARLY CLOSING WEDNESDAY

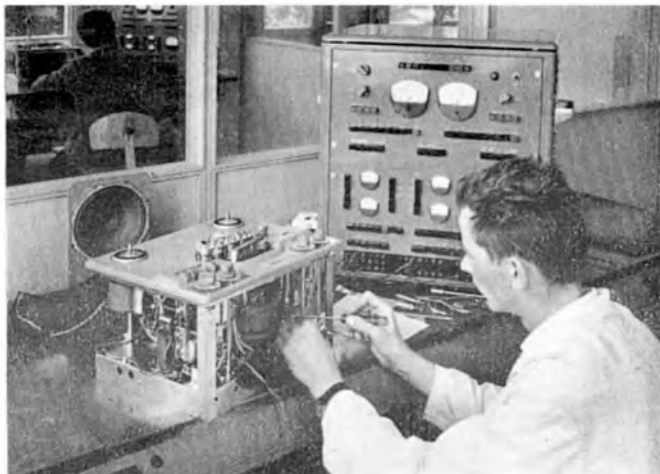

Would you qualify as a Revox engineer?

If you have the enthusiasm and technical skill to match this precision tape recorder and are able to make your work base Windsor we invite you to write, call or telephone for an early appointment. Applicants have the prospect of graduating to a position with the Revox International Operation in North America.

C. E. HAMMOND & CO. LTD.
90 High Street, Eton, Windsor, Berks.
Telephone: Windsor 63388

Leda Tape

FULLY GUARANTEED ☆ STRONGLY BOXED

Size Base	Standard		Long	
	P.V.C.			
3"	150'	2/3	225'	3/-
4"	300'	3/9	450'	5/-
5"	600'	8/3	900'	9/9
5 3/4"	900'	10/-	1200'	12/3
7"	1200'	12/3	1800'	17/3

Size Base	Double		Triple	
	POLYESTER			
3"	300'	4/3	600'	8/9
4"	600'	8/3	900'	12/6
5"	1200'	15/3	1800'	22/6
5 3/4"	1800'	19/3	2400'	28/6
7"	2400'	21/9	3600'	38/6

Factory Fresh. Superb Quality. Leaders, Trailers and Stop Foils on all sizes 5" and above. We supply many local authorities and professional recording studios. May we supply you? P. & P. 2/6 per order. S.A.E. Full Lists.

LEDA TAPES (T), 30 BAKER ST., LONDON, W.1



NATURE NOTES

FOR MAY

BY RICHARD MARGOSCHIS

SPRING! The time when anyone interested in bird song should be spending every possible minute outdoors. As May proceeds so the dawn chorus will improve; it should be at its best around the end of the month. This is a wonderful, awe inspiring sound which natural history recordists will wish to attempt. In order to get the full benefit you must be installed in your chosen location well before the break of dawn, and at this time of the year that means soon after 4 a.m.; if you arrive at 5 a.m. you will come in at the middle, and by 5.30 it will be gone. Robin and blackbird will be among the first to start and other species will add their song one by one as daylight increases, until the whole symphony reaches its crescendo and then gradually dies away. I have called it a symphony but it might well be a cacophony if you happen to get jays and birds with similar voices joining in.

The way the sound is built up by one species following another is interesting, for it follows a regular pattern and I have seen it suggested that it is connected with light intensity affecting the bird's eyes. This could explain why a robin, as well as being an early riser, sings late into the evening, and perhaps the nightingale is the exception to the rule. Incidentally, I have heard a robin singing late into a February evening as he sat on a branch alongside a sodium street lamp.

Whilst the dawn chorus is in full swing there is little hope of recording individual birds, but as it dies away, and for a couple of hours afterwards, conditions are often ideal with reduced trouble from wind and ambient noise.

If you have been watching for evidence of nest building now will be the time to look out for song posts used by the cock bird as his hen is hatching, providing an opportunity of placing an open microphone very near to the singing bird. This is a technique which calls for a lot of observation and patience, for once the microphone is placed it cannot be moved without disturbing the bird and having to start all over again. If it is possible to place two, or even three microphones so much the better; they can be connected to the recorder through a battery operated mixer or simple switching device, or even by inserting the correct plug for whichever post the bird happens to choose.

One of the most common songs just now is that of the willow warbler or willow wren. I mentioned this bird last month because of his similarity, visually, to the chiffchaff, but the song is so very different and recordings of it always make me think of pleasantly warm, sunny days in May and June. Starting high and gradually descending, with well sustained notes particularly at the start, it is a calm, unhurried song and although it is soft it carries a remarkable distance. The bird can be found almost anywhere where there are trees or scrub and generally sings from large trees, but has no preference to willows. It has a thin bill, is greenish-brown with pale underparts and a pale line over the eye. The nest is in cover near the ground, is domed and made of grass and feathers.

Last month I spoke about the cuckoo and claims of "first hearings". By February 16 not only had such a claim been made but in the "World at One" Programme a BBC interviewer spoke to a man who claimed to have recorded it in his garden that morning. The tape was played, apparently over a telephone line, and sure enough a sound like a cuckoo's call was heard twice. Before the programme ended others had telephoned to say they also had heard the bird. Any comments?



TELEFUNKEN

Wonderful stereo Wonderful value

Is it any wonder more enthusiasts are going for the M204E?

Yes, it's true, more and more people are discovering the excellence of the M204E. The man who buys one invests in a craftsman-built 4-track machine that has everything the higher priced machines can boast, except the higher price. Signal-to-noise ratio, for instance: a desirable high value of 50 dB. And wow? Well, WOW!!... a mere third of 1% at 3½ ips, a fifth of 1% at 7½ ips. Output is from two healthy 6 watt push-pull stages. Up to 12 hours of listening pleasure from one 7" tape. Hear the excellence of an M204E at your local specialist dealer. And don't waste time. The longer you delay your purchase, the more it's costing you in the personal enjoyment you're missing. Recommended retail price: £136. 12. 5. Write today for fascinating FREE colour booklet to AEG (Great Britain) Limited 27 Chancery Lane London WC2.



**3³/₄
IPS
TWIN
TRACK
MONO
TAPES**



THE MOVE – Move
REGAL ZONOPHONE TA-LRZ 1002



MRS. MILLS – Summer Party
PARLOPHONE TA-PMC 7046



THE SUPREMES – Supremes a' Go-Go
TAMLA MOTOWN TA-TML 11039



THE TEMPTATIONS – Temptations Greatest Hits
TAMLA MOTOWN TA-TML 11042

MUSICASSETTES

Stevie Wonder

I Was Made To Love Her
Tamla Motown TC-STML 11059

The Four Tops

The Four Tops Live
Tamla Motown TC-STML 11041

Basil Henriques and The Waikiki Islanders

Shades of Hawaii
Columbia TC-SCX 6189

**Mr. Acker Bilk with
The Leon Young String Chorale**
Mr. Acker Bilk's Folio of Great Songs
Columbia TC-SCX 6224



EMI
THE GREATEST RECORDING
ORGANISATION IN THE WORLD

E.M.I. RECORDS (THE GRAMOPHONE CO. LTD.)
E.M.I. HOUSE, 20 MANCHESTER SQUARE, LONDON W.1

NEW PRODUCTS

NOTE: All prices quoted in both editorial and advertisements in this edition of *TAPE Recording Magazine* are subject to the addition of Purchase Tax where applicable.

FERROGRAPH SECOND GENERATION

SINCE the introduction of the very first model Ferrograph in 1950 development has been confined to logical evolution based fundamentally on the original design. Now with the Ferrograph Series 7—described as “second generation machines”—we have for the first time radical departures from the original concept.

The all-silicon solid state electronics with FET input stages and wide input overload margins have been specially evolved, together with a completely new three-motor tape transport system incorporating variable speed spooling control for easy indexing and editing. The three individual units, tape deck, power unit and amplifier complex, are mounted on a single frame easily removable from the cabinet for service or installation in other cabinets or racks. As with Series 6 models three speeds will be available and these may be either 1½, 3½ and 7½ ips. or in the high speed versions 3½, 7½ and 15 ips. Electrical deck operation allows presetting for time switch starting without the need for the machine to be previously powered and provision for instantaneous stop/start is provided by electrical remote control.

Deck operation is controlled by a single lever knob with pause position linked to an independent press-to-record button for safety and to permit click-free recordings and insertions. Adjustable reel height control is provided and damped tension arms provide slur-free starting. Maximum size reel is 8½ in., endless loop cassettes may be used and provision has been made for signal operated switching units. Immediate access to the head block for editing and cleaning is available.

Models with output stages are provided with two internal loudspeakers—one each channel on stereo or two phased on mono. The two inputs per channel are provided with independent mixing facilities (ability to mix four inputs into one channel on stereo machine). The signal level meters for each channel are operative on playback as well as record and tape/original switching follows through to output stages. A re-record facility on stereo models for multiplay, echo effects, etc. has been provided without external connections. The meters are switchable to read 100 kHz bias and erase supply with accessible preset adjustment.

Three outputs are provided per channel: one, line out—level response, two, line out—after tone controls, three, power output—8-15 ohms. Independent tone controls give full lift and cut to both bass and treble on each channel. The retractable carrying handle permits carrying by one or two persons and the equipment will be available in several alternative presentations as from the end of May.



Prices are as follows (high speed versions in every case being £5 dearer).

Model 713 mono half-track 10 watts RMS output, £110.

Model 715 mono full-track, 10 watts output, high speed only, £140.

Model 702 stereo half track, no audio output stage, £130.

Model 722 stereo half-track, 2×10 watts, RMS output, £150.

Model 704 stereo quarter-track, no audio output stage, £130.

Model 724 stereo quarter-track, 2×10 watts RMS output, £150.

The Ferrograph Company Limited, 84, Blackfriars Road, London, S.E.1.

BASF LOW NOISE TAPE AND HOBBY BOX

LOW noise tapes are becoming increasingly popular and BASF now announce the introduction of their PES 35 LH low noise high output tape. Described as specially suitable for amateur users it is available in a range of spool diameters from 5 in. to 10½ in., a typical cost being 58s. 6d. for a 7in. diameter spool containing 1,800 feet.

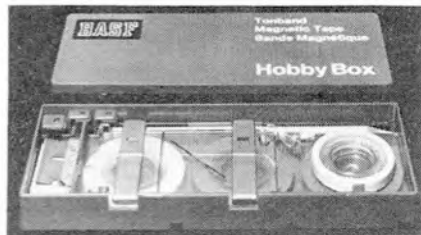

Another new introduction by BASF is the Hobby Box. Containing a splicer, marking pencil, razor blade, 33 feet of splicing tape, three 80 ft. lengths of red, white and green leader tapes, fifty pieces of 6 in. metallized foil, twenty-five spool labels in green and red and three tape clips, this comprehensive outfit costs 32s. 6d.

BASF UK Limited, 5a Gillespie Road, London, N.5.

YOUR LOCAL DEALER

LONDON

Lee Electronics

THE TAPE RECORDER & HI-FI AUDIO SPECIALISTS

400 EDGWARE RD., LONDON, W.2 (PAD 5521)

London's leading Stockists of High-Fidelity and Audio Equipment. Many bargains in new and reconditioned equipment.

SEND FOR FREE LISTS OF RECORDING TAPES, RECORDERS, AMPLIFIERS, ETC.

APPOINTED B. & O. AGENTS

- ★ TAPE RECORDER HIRE
- ★ TAPE TO DISC 78 & LP
- ★ RECORDING STUDIO
- ★ TAPE RECORDER REPAIRS
- ★ SALES—EXCHANGES

MAGNEGRAPH

1, Hanway Place, London, W.1.
Tel.: LANGham 2156

THEATRE ORGAN DISCS and TAPES

ORGAN OF THE MONTH CLUB brings out a new Theatre Pipe Organ record each month.

Our discs are playable on Mono or Stereo equipment. Approx. 38 minutes playing time 31/6d.

7½ i.p.s. 4 track stereo tapes 41/7d.

Full details from:

CONCERT RECORDING
P.O. BOX 2,
ROTHWELL, KETTERING, NORTHANTS

When visiting the Audio Fair at the Russell Hotel don't forget the many exhibitions being held concurrently at adjacent hotels. These are:

At the Grand Hotel Heathkit will be showing their many products, all of which are available as kits or ready-built. Also at the Grand, Motion Electronics and Audio Research.

At the Tavistock Hotel the new Techno-mark group will show Bang & Olufsen, Sony and Radford equipment.

At the Morton Hotel Transatlantic Music Tapes will exhibit the Viking range of tape recorders, Telex headsets and CBS and RCA tape records.

At the Hotel President, Howland West and MAC Electronic Co. will show a comprehensive range of accessories and equipment.

YOUR LOCAL DEALER

LONDON

Masseys of Sound Centre

West London's Hi-Fi tape Recorder Specialist
—Demonstration Room with Comparator

APPOINTED FERROGRAPH DEALER

AT
CHISWICK, W.4

Accessories, All Kinds—Servicing—Pre-Recorded
Tapes Mono/Stereo

121-123 High Road—10 a.m.—7 p.m.

◀ TEL: CHI 2082 ▶

(not closed for lunch)

TAPE RECORDER HI-FI CENTRE (SHEEN) LTD.

—The Centre for—

FRIENDLY HELP—SALES—SERVICE
DEMONSTRATIONS ANY TIME—ALL PRE-
RECORDED TAPES—STEREO—MONO
LANGUAGES—DANCE—JAZZ—SHOWS
CLASSICS, etc.—2 and 4 TRACK—STOCKISTS
OF ALL MAKES AND MODELS OF RECORDERS
AND HI-FI—Add sound to your movies with
Synchrodek—WE ARE STOCKISTS OF
SYNCHRODEK

TERMS—EXCHANGES, ETC.

3/4 STATION PARADE, SHEEN LANE,
SHEEN, LONDON, S.W.14

(Opposite Mortlake Station, S.R.)

Showroom: PROspect 0985

9 a.m.—6 p.m. Closed Wednesdays.

THE SOUTH

THE SOUTH WEST TOM MOLLAND LTD.

Invite you to visit their
well-equipped
Demonstration Theatre and
compare all the leading makes of
Hi-Fi and Tape Equipment at
110 CORNWALL ST., PLYMOUTH
Telephone 69285
Immediate delivery to ALL Areas

MUSICASSETTES

Send 6d. in stamps for comprehensive catalogue,
part-exchange details and library service.

All makes of cassette machines are supplied at
cut-cash prices.

Blank cassettes, Carrying cases, Language
Courses, etc.

ALL MUSICASSETTES REVIEWED
IN THIS MAGAZINE ARE AVAIL-
ABLE FROM US BY RETURN POST

THE MUSICASSETTE SUPPLY COMPANY
13 Angel Street, Worcester

For Jiffy-fast Postal Service

STEREO 70 BY H. J. LEAK

STYLED by Noel Hearing Associates, Stereo 70 by H. J. Leak Ltd., is claimed to function electronically to the highest standards obtainable by present techniques—to the performance standards demanded by communications engineers for broadcasting and recording. The manufacturers conclude



by saying that there is nothing that can be added to the circuitry or the price to improve the fidelity of reproduction obtainable from the "Stereo 70"; it will give optimum musical results from records, tape, radio or microphone.

The two identical circuits are designated "L" for the left-hand input signal and "R" for the right-hand. Each circuit uses a low noise, low distortion, four stage feed-back tone control preamplifier section. The third and fourth stages embody feed-back tone control circuits which give continuously variable control over both bass and treble frequencies. The output from each preamplifier section feeds into a six-transistor, four-stage, power amplifier. This has been designed in a directly coupled transformerless push/pull configuration with over 60 dB of negative feedback which is claimed to reduce all forms of distortion to inaudibility.

Power output per channel, sine wave driven, is said to be 35 watts RMS each into 8 ohm loudspeakers or 28 watts RMS each into 15 ohm loudspeakers. Total harmonic distortion is given as 0.1 per cent for all power levels up to 25 watts RMS each channel at 1 kHz into either an 8 ohm or 15 ohm loudspeaker. The required power supply is 110-250 volts 40/60 Hz. A wide and flexible range of input facilities are available including "off tape" monitoring for tape recorders with separate replay head and separate record and replay amplifiers.

Prices are £63 for the chassis model and £69 10s. for the free-standing model in teak enclosure.

H. J. Leak & Co. Limited, 57, Brunnel Road, London, W.3.

NEW BRITISH TAPE RECORDER

DESIGNED to compete with top quality continental domestic recording equipment, the Chilton 100S solenoid operated tape recorder is a new British equipment by a new name in the lists of British tape recorder manufacturers — Magnetic Tapes Limited.

The three speed deck operating at 7½, 3½ and 1½ ips accepts maximum 7 in. diameter spools and is claimed to have a long term speed stability of plus or minus 1 per cent from start to finish of reel. Frequency response is quoted as from 40-15,000 Hertz plus or minus 2 dB at 7½ ips, 50-7,500 plus or

minus 2dB at 3½ ips. and 50-5,000 Hertz plus or minus 3 dB at 1½ ips. Automatic bias adjustment has been provided at all three tape speeds.

Distortion is given as 2 per cent at peak record level, 7½ ips., and less than 1 per cent at 10 watts RMS output 50-10,000 Hertz. Claimed signal-to-noise ratio is minus 52 dB at 2 per cent distortion with bass/treble controls set to a level response at the range 50-10,000 Hertz (typically minus 60 dB at 7½ ips.).

Total wow and flutter is said to be no greater than 0.1 per cent RMS at 7½ ips. from start to finish of the tape, and the treble and bass Baxendale type tone controls offer 10 dB of cut or boost at 50 and 10,000 Hertz.

Record level indication is by a pair of illuminated peak programme meters calibrated in dBs and the stabilised power supply has a positive cut-out if loudspeaker or supply is overloaded or shorted. This cut-out reverts to normal as soon as the short is removed. There is provision for both multiplay and echo and before/after record monitoring via the separate record and playback heads and amplifiers.



Available in either half-track or quarter-track versions the dimensions are 15¼" x 15¼" x 7", less lid, and the weight is 32 lbs. Finish is satin chrome and charcoal grey deck with oiled teak cabinet and the recommended retail price is 115 guineas less tape and microphone.

Magnetic Tapes Limited, Chilton Works, Garden Road, Richmond, Surrey.

AN IRON FOR ELECTRONICS

DELICATE electronic components demand precision soldering. Antex are now marketing their 15 watt Model CN iron fitted with the popular No. 2 nickel plated bit.

This iron is said to be specially suitable for use on transistor and miniature circuits and costs 31s.



Antex Limited, Grosvenor House, Croydon, Surrey.

MUSICASSETTE

REVIEWS

BEETHOVEN. Piano Concerto No. 5 in E Flat Major, Opus 73, "Emperor." Claudio Arrau, piano, and the Concertgebouw Orchestra Amsterdam, conducted by Bernard Haitink. Philips CPC 0019. 40s.

The arrival of this musicassette was awaited with particular interest. The Emperor Concerto is not only full of dynamic and dramatic musical sound, but the solo piano part is a great challenge to both performer and recording engineer alike. It also challenges the efficiency of the reproducing system.

To be honest, one tends to listen to classical musicassettes of this kind with a hyper-critical ear. It is quite natural that one should listen for the kind of sound that would make one say, "Ah, there you are, it doesn't work. 1 7/8 ips is just not good enough."

But at no point could I make that remark about this record. In spite of the slow speed and narrow tape the piano of Claudio Arrau was reproduced with reality and presence. Even sustained notes appeared to lack the traces of wow that have been noted in some of the more popular albums. Quite apart from providing an inspiring and uplifting musical experience this musicassette also achieves another object in helping to prove that the system *does* work—whatever anyone might imagine to the contrary.

The Emperor Concerto is too well known for me to waste space describing it. Like so many of Beethoven's compositions it is nowadays regarded as coming within the "popular" classical repertoire. The performance of the Concertgebouw Orchestra and the soloist Claudio Arrau under the baton of Bernard Haitink is a truly memorable experience. With blazing brilliance the Emperor Concerto moves towards its thundering finale. This recording carries the listener along—mundane trivialities such as tape speed or recording systems are overwhelmed and forgotten by the sheer joy of the music. A memorable addition to the Philips classical list and as such very strongly recommended.

TOP DANCE TIME. Joe Loss and his Orchestra. EMI TTC-CSD 3644, 40s.

Beneath the uninspiring title of this album lies hidden some very good recorded quality. Standards are not maintained throughout all the thirty-six numbers; the occasional flashes of brilliance do tend to throw up in sharp relief the poorer quality of other sections.

However, one cannot fault the strict dance tempo, to conform with which the items are grouped in Quickstep, Waltz, Foxtrot, etc., medleys. Space will not permit the listing of the entire repertoire, but be assured that if you are one who has ever answered the call to "Come Dancing" then this is the album for you. Others will probably be bored to death with it.

I should mention that the recording imperfections (when they occur) are not so severe as to detract from the enjoyment of those for whom it was obviously intended and whose concern will surely be focused on their feet rather than their ears.

GIPSY FIRE. Ron Goodwin and his Orchestra. EMI TC-SCX 6187. 40s.

The favourite gipsy tunes that go to make up this collection could have provided some very pleasant entertainment. As it is the whole is spoiled by thoroughly muddy and generally incompetent recording technique. The album includes: *The Gipsy Fiddler, Black Eyes, The Ritual Fire Dance, Andaluza, La Paloma, Gipsy Moon, Czardas, Hora Staccato, Bublitschki, Play Gipsy, Two Guitars and Hejre Kati.*

After listening carefully several times I had to conclude that recorded quality was so poor that I could not recommend this album to any category of listener. A pity, because this is the traditional romantic music of the intimate cafe table. But I fear that if the lady has any sensibility at all the atmosphere will be destroyed rather than enhanced by what this album has to offer. Will the publishers please try harder next time?

I WISH YOU LOVE. Ken Dodd. EMI TC-SCX 6166. 40s.

Not being an enthusiastic admirer of Ken Dodd, either as comedian or vocalist, I approached this album with some caution. What I heard confirmed my opinion that comedians should devote themselves exclusively to the art of being funny, but at the same time I had to admit an ungrudging admiration for the manner in which the recording had been undertaken.

With plenty of full range sound Ken Dodd is presented well in the foreground and his voice is endowed with reality and presence to make a thoroughly good and acceptable recording.

The items offered include: *Somewhere my Love, What'll I do, If, The Sun is always shining somewhere, They didn't Believe Me, When there was you, As time goes by, You were meant for me, Time goes so slowly, Among my Souvenirs, How Long is Forever.*

POURCEL POUR VOUS. Franck Pourcel and his orchestra. HMV, EMI, MCV 16004. 50s.

One needs only to hear the first couple of bars from this French imported musicassette (hence the increased price of 50s., and, by the way, it is double mono not stereo) to realise that this is something dramatically good in sound quality. Every now and then we get our hands on a musicassette that produces sound of shining demonstration quality. To find one is exciting; this is one, and believe me I was excited.

If "Pourcel Pour Vous" is an example of what our friends across the channel are up to in the recording world then I can only hope that we shall have the chance to examine some more examples of their work in the very near future. This album is absolutely brilliant and is a great credit to all who had a hand in producing it.

The collection includes: *Puppet on a String, L'Important c'est la rose, Somethin' Stupid, L'Amour est Bleu, Sunrise Sunset, Il doit faire beau la-bas, Ta ta ta ta, Je vous offre, Penny Lane, Free again, Kiss me Goodnight and C'est ma chanson.*

The tape is very heavily loaded, a technique which enables volume controls to be eased back, so achieving an improvement in signal-to-noise ratio. In fact the engineers were dangerously on the brink—in *Penny Lane* there is just a suspicion of distortion on the peaks but in all other respects living dangerously has produced outstanding technical results. Very strongly recommended.

YOUR LOCAL DEALER

THE NORTH

CHESHIRE

CHARLESWORTH'S
OF CREWE LTD.

Tape Recorder
and Hi-Fi Specialists

Head Office: 14 Hightown, Crewe, Tel. 3327

Hi-Fi CENTRE: 28 HIGHTOWN, CREWE.

Technical Division: 19 Ludford St., Crewe.

**TAPE RECORDER
CENTRE (HALIFAX)**

stock all the best
Tape Recorders, Hi-Fi Equipment,
Tape, Pre-Recorded Tape, etc.

REVOX
specialist

30 King Cross Street, Halifax
Phone 66832

**CUSSINS &
LIGHT LTD.**

YORK'S LEADING RADIO
TV & ELECTRICAL STORE

Visit our First Floor
TAPE RECORDER
CENTRE

LARGEST RANGE
OF RECORDERS
& ACCESSORIES
IN THE NORTH

KING'S SQ.
YORK



Any
MUSICASSETTE
BY RETURN POST

Our catalogue lists every available
Musicassette in detail. Send for your
FREE copy now (enclose 6d. stamp
for postage)

**LIBRARY AND PART EXCHANGE
SERVICE AVAILABLE**

For double quick mail order service
send to:

GRAMO-TAPES LTD.
Newport Crescent, Middlesbrough.

3 $\frac{3}{4}$ ips MONO**CARELESS LOVE.** Des O'Connor. Columbia TA-SX 6208. 35s.

Most of us have seen Des O'Connor on his recent television series. Now, I don't know him personally, but the image that came over the screen was that of a thoroughly nice guy with a frank, open appeal to—for want of a better classification—"the housewife."

This tape would be perfect for a housewife. Des sings his way through twelve songs that are almost tailor-made to lighten household chores. To put them on a recorder and play them over would be equally as stimulating to the average home-bound wife as to listen to Radio One's current Jimmy Young show in the morning.

The quality of recording is not so good. Balance between singer and orchestra is rather equal, to result, here and there, in a "woolly" sound. And also, of course, there is the rather irritating similarity between Des O'Connor's voice and that of Dean Martin. Irritating, because I personally think that a man should have his own voice.

But that's a small niggle. I would say this. If you have a mass of tape-recording equipment that you have bought despite the menacing, "what-about-the-new-bedroom-suite" glances of your wife, get this tape and slap it on as you leave for work. It'll go down a treat, and you may find your spouse appreciating your investment by the time you come home.

Careless Hands (a recent hit, but frankly no better than the rest of the very pleasant selection) is followed by *You Always Hurt The One You Love*, *Never On Sunday*, *I'll Always Be in Love With You*, *Anytime, Somethin' Stupid*, *When You're Smiling*, *All My Love*, *Your Cheatin' Heart*, *I Had The Craziest Dream*, *Can't Get Used To Losin' You*, and *Red Roses For A Blue Lady*.

MIREILLE MATHIEU. Columbia TA-SX 6210. 35s.

I cannot speak too highly of this tape. At a time when General de Gaulle is making himself a considerable nuisance. I suppose we all ought to revert to the opinions of our ancestors who raved about "Boney" and think in terms of "frogs" for our neighbours across the channel.

However, no frog ever croaked like this. Mireille Mathieu is the most delightful of singers. The recording is impeccable. I defy (vive le resistance) anyone to say a word against this excellent selection that EMI have seen fit to import for us. Listen, mes braves, to the guitar on the second track of side one. Formidable! Ze balance, she is superb, no?

Those of us who believe that our enemies begin three miles off Dover will of course reject this tape as rubbish. I feel sorry for them. Those of us who remain insular, yet without crushing prejudice will possibly remark sadly that all the tracks are in French, and therefore a bit beyond the "plume de ma tante" bit . . . but I counsel them to be tolerant. The words are French, yes. But surely the more delightful for that?

Tracks: *La Dernière Valse*, *La Vielle Barque*, *Quand Fera-t-il Jour Camarade*, *En Ecoutant Mon Coeur Chantant*, *Ponts De Paris*, *Un Monde Avec Toi*, *Les Yeux de l'Amour*, *La Chanson De Notre Amour*, *Chant Olympique*, *Seuls Au Monde*, *Quelqu'un Pour Toi*, and *L'Amour*.

7 $\frac{1}{2}$ & 3 $\frac{3}{4}$ ips STEREO

Equipment used for review tapes: Amplifiers—Quad valved and Wharfedale transistorised. Loudspeakers—Celestion and Jordan-Watts. Tape Recorders—Akai 3000D and Tandberg 64X.

VERDI. Requiem Mass. Elisabeth Schwarzkopf, Christa Ludwig, Nicolai Gedda, Nicolai Ghiaurov with the Philharmonia Chorus and the Philharmonia Orchestra conducted by Carlo Maria Giulini. Angel ZB 3649 4-track stereo 7 $\frac{1}{2}$ ips. 120s.

Verdi—the King of Opera. Opera—the quintessence of dramatic music, the fusing of concert hall with theatre. Verdi's Requiem Mass demonstrates perfectly what happens when such a composer turns from pure entertainment to religious thought. The result—a theatrically ecclesiastical piece.

Regrettably, no single word of explanation is offered with this double length Angel recording (total duration 87 minutes 30 seconds). The box lists the artistes and quotes the movements but that is all. There is not one word to encourage the uncertain prospective purchaser. I would like to have been told that this work is not a true composition for the church in the classical sense but rather a statement of the composer's sincerest and most profound feelings in the development of which he did not hesitate to exercise his mastery of dramatic art. I would like to have been warned to expect a work of theatrically operatic feeling rather than of heavily obtrusive liturgical involvement.

In his Requiem we see the release, perhaps the perfect release, of the blithe spirit of Verdi. Free from the claustrophobic influence of formal dogma, this man of the theatre expresses himself in the only way he sincerely could; in theatrical language. Lovers of Verdi opera would not be far wrong if they considered the Requiem in terms of his most sublime operatic composition. Certainly it is nearer to this point than it is to the drab character of some church music.

And to delight us in this operatic experience we have a brilliant cast headed by the incomparable Elisabeth Schwarzkopf. Again I must single out Nicolai Gedda for special mention. His brilliant tenor voice never fails to impress me. The Philharmonia Chorus and Orchestra provide all the fireworks called for in the score—and there are plenty—with a grace and ease that is entirely suited to the occasion. My adulation of this album stops short at recorded quality. Unfortunately this does leave something to be desired. General over-brilliance and excessive hiss indicate the need for top cut. One would not complain too severely if this were to be the only fault but unhappily there is distortion in some of the heavily modulated passages and this does show up badly in the reproduction of the human voice.

I must summarise my remarks by noting this imperfection on what is otherwise an excellent performance of a magnificent work. It is in my opinion of such great musical merit as to be absolutely worthy of acquisition in spite of its failings. After all, hi-fi is not everything for everyone! Personally, I wouldn't part with my copy for anything.

WEST MEETS EAST. Yehudi Menuhin and Ravi Shankar with Hephzibah Menuhin, Alla Rakha and Prodyot Sen. Angel YIS 3418 4-track stereo 3 $\frac{3}{4}$ ips. 75s.

Rarely have I had such mixed feelings about an album as I have about this one. It comprises not so much a meeting between West and East as a head-on collision. Side 1 is devoted to three Indian compositions, the first performed by Yehudi Menuhin, violin, with Alla Rakha tabla (drums), the second by Ravi Shankar sitar, and the third a duet for violin and sitar. Side 2, presumably a compromise half-way pause on our return to the West, offers Yehudi with his sister Hephzibah at the piano in *Enesco's Sonata No. 3 in A Minor*.

Starting with Side 1 I first noted the acceptable recorded quality in spite of the 3 $\frac{3}{4}$ ips speed. The more usual higher speed costs only more tape and effectively reduces background noise. Unfortunately I suspect commercial interests are going to persuade publishers to work at 3 $\frac{3}{4}$ ips more and more frequently in the future. This retrograde step is greatly to be deplored. Returning to this particular example I must add that the stereophonic effect is excellent.

Comment on the music of Side 1 is more difficult. Approaching this album with innocent western ears I can only be honest by offering purely subjective opinions. To most of us this tape will be a curiosity, to be heard with more speculation than understanding. The violinist's paragraph of introduction—couched in flowery terms—does not help very much. One is left with the music and the task of appreciating a wholly foreign culture.

Let us make no mistake, the sitar is a wonderfully expressive instrument and I have not the slightest doubt that the message is there for those with the ears to hear or for those with the patience to learn to hear. I am proud to number an Indian family among my dearest friends. I used to take for granted their love for, and deep knowledge of, western music. This is surely a selfish and unreasonable attitude. It's time we westerners stopped being so egocentric and started trying to extend a little understanding in the opposite direction. I only wish my friends were back in England instead of being in far-away Bombay. As it is I listened without guidance and found it to be a most enjoyable, if sometimes incomprehensible, experience.

Rumanian born Enesco had a thoroughly western training in Paris, but his music is strongly nationalistic. This violin and piano sonata is not heard too frequently and it offers an appropriate link between the Continent of India and Europe. Recording is again as good as the tape speed will allow; top cut is required to subdue hiss but both instruments have realistic presence.

The Enesco work is expressive of great thoughtfulness. And so I will commend this album only to the serious minded who will find in it much to occupy them. For others it is likely to be more of an enigma.

PURCHASE TAX

Prices of all pre-recorded tapes quoted in these reviews are subject to the addition of Purchase Tax at 50 per cent.

Typical examples are:

Musicassettes up from 40s. to 54s. 6d.

3 $\frac{3}{4}$ ips Mono tapes from 35s. to 47s. 9 $\frac{1}{2}$ d.

7 $\frac{1}{2}$ ips. Stereo tapes from 75s. to 102s. 5d. or 103s. 4d.

Some dealers to continue to offer existing stocks at pre-budget prices.

JAN FEB MAR APR

MAY JUN JULY

AUG SEPT OCT

NOV DEC

DID YOU KNOW—

- That **TAPE RECORDING MAGAZINE** was the First Publication of its kind in Europe.
- That it is still the Best Tape Recording Magazine.
- That it is the only Tape Recording Magazine staffed by Enthusiasts for Enthusiasts.
- That you can ensure receiving your regular monthly copy by handing your newsagent the coupon below.
- **THAT TAPE RECORDING MAGAZINE IS STILL ONLY 2/- MONTHLY.**

TO MY NEWSAGENT

I would like to be sure of receiving **TAPE Recording Magazine** regularly. Please order it for me.

NAME

ADDRESS

.....

.....

TAPE Recording Magazine is distributed by Trans-World Circulation Co.

VIKING MEANS

EXTRA VALUE IN HI-FI

STEREO TAPE RECORDERS

Now, for the first time, you can enjoy the superior reproduction and quality engineering of one of America's finest full fidelity tape recorders that is styled for your lounge, but built like a piece of laboratory equipment.

The NEW Viking Model 433 makes a beautiful sound and is unequalled for operating simplicity and reliability. It has three motors, three hyperbolic heads—no pressure pads—off the tape to original monitoring; echo switch, sound on sound and a separate monitor volume control for each channel. An eight position function switch illuminates colour coded windows, there's a four digit counter; automatic shut off; fool-proof tape motion and record switch interlock; three speeds and solid state electronics. Just plug in to your existing Hi-Fi—you'll hear the difference, or with VIKING 4400 energised loudspeakers you need no elaborate Hi-Fi amplifiers. The 4400 energised loudspeakers deliver 30 watts of music power per channel at a frequency range from 40 to 17,000 cps. There are two superb loudspeaker units in each enclosure with separate volume control, headphone jack, bass control and on-off switch. The 4400 will also accept and produce wonderful music from your tuner and record player.

ONE OF THE WORLD'S FINE TAPE RECORDERS

VISIT THE AUDIO FAIR 18 TO 21 APRIL 1968

SEE AND HEAR THE VIKING

EXHIBIT AT THE MORTON HOTEL

WOBURN PLACE

(JUST AROUND THE CORNER)



MODEL 433

VIKING

tape recorders

A DIVISION OF THE
TELEX CORPORATION

U.K. Distributors

TRANSATLANTIC MUSIC TAPES (DISTRIBUTORS) LTD.
BRISTOL & WEST HOUSE, HIGH STREET, SALISBURY, WILTSHIRE

Faithful Reproduction

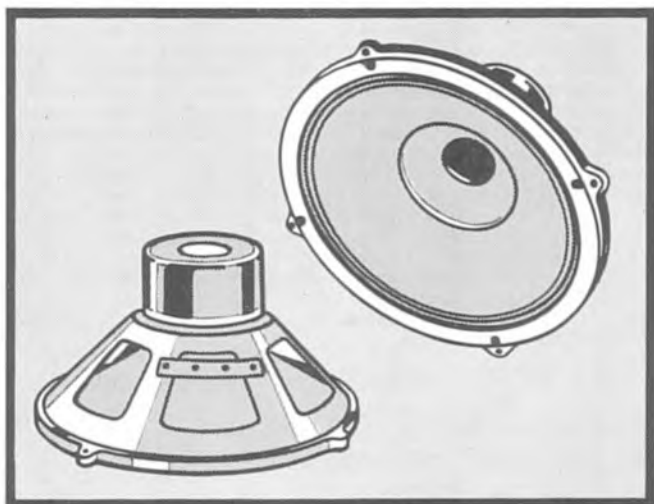

with the Grampian TC12 loudspeaker

The Grampian TC12 loudspeaker is a high quality twin cone unit at a reasonable price. The loudspeaker is built of high quality materials to a rigid specification and is eminently suitable for good quality sound reproduction. Let us send you full details or better still go and hear one at your local dealers now.

Design for suitable cabinet available.

Grampian manufacture high grade microphones, parabolic reflectors, windshields and accessories, also mixers and amplifiers.

Grampian SOUND EQUIPMENT
Integrity that you hear

Send for leaflet giving full details

GRAMPIAN REPRODUCERS LTD

Hanworth Trading Estate, Feltham, Middlesex
Tel: 01-894 9141/3 Cables REAMP, FELTHAM

A REEL Deal...

FOR ALL OWNERS OF 4 TRACK
TAPE RECORDERS

69/- VALUE FOR 45/-



STEREO 3 3/4 ips 4 TRACK 50/-

(Including Purchase Tax)

(A 90-minute Music Tape value 45/- and a 24/- reel of Polyester Base Long Playing Recording Tape—1 mil—all for 45/-)

This offer enables you to realise the excellent value of the new 4-track tapes released by RECOTAPE and to verify the quality of the new formula RECOTAPE Recording Tape.

Each of the new Recotape 4-track tapes is equal to two complete recordings. Playing time of 45 minutes costs only 25/- up to 130 minutes for 45/-.

MUSIC FOR ALL plays at 3 3/4 ips and can be used on all 4-track Mono or Stereo recorders.

Contents:

William Tell Overture, played by the Vienna State Opera Orchestra; Quanta La Gusta, played by the London Brass Ensemble; Waltz from Swan Lake played by Vienna State Opera Orchestra; Dream of Olwen played by Syd Berman and His Sound Stage Symphony; Somewhere Over the Rainbow, played by The New Metropolitan Theatre Orchestra; Grand March from Aida played by Vienna State Opera Orchestra; March, El Capitan, played by Massed Military Bands; Waltz, Artists Life, played by the Vienna State Opera Orchestra; Stranger in Paradise, played by Syd Berman and His Sound Stage Symphony; Gipsy Airs, played by the Sudwesfunk Symphony Orchestra; Heatwave, played by Larry Moreton and His Hammond Organ, and Overture 1812, played by the Vienna Symphony Orchestra.

**YOU GET MORE MUSIC
AT LESS COST WITH . . .**

RECOTAPE 4 TRACK TAPES

Ask your dealer for this tape, in case of difficulty send direct to:—
Recotape Recordings Limited, 36 High Street, Salisbury, Wilts.

**VISIT THE AUDIO FAIR 18-21 APRIL
SEE OUR EXHIBIT AT THE MORTON HOTEL on the
opposite corner in Woburn Place. . .**



Over 200 different Tape Recorders to choose from: ONLY ONE IS RIGHT FOR YOU

AUDIO FAIR 1968

During the period of the **Audio Fair** and continuing to the **end of May** we will have on display all the **new models** from the **Audio Fair** which our expert staff will be pleased to demonstrate.

SONY VIDEO

Whilst in our showrooms see the fantastic new Sony Video Tape Recording equipment. Daily live recordings and demonstrations of this revolutionary new electronic equipment.

ONLY AT THE TAPE RECORDER CENTRE can you see, hear and compare all the best tape recorders from Britain, Denmark, Sweden, Japan, Germany and elsewhere. The latest Akai, Bang and Olufsen, Tandberg, Sony, and all other famous makes are available for immediate demonstration and comparison.

YOUR WISEST MOVE is to visit **THE TAPE RECORDER CENTRE** under our Free Travel scheme, where you can see tape recorders priced from 20 gns. to 500 gns., also a wonderful selection of brand new models, shop soiled and second hand tape recorders showing savings of up to 60 per cent.

- **GENEROUS PART EXCHANGES**
- **FREE AFTER SALES SERVICING**
- **EASIEST HIRE PURCHASE TERMS**
- **EXPERT STAFF EXPERT ADVICE**

Only one minute from Holborn Underground Station. Open Sats. until 1p.m.

Please send me T.R.C. Brochure and **Free Travel Voucher**

Name

Address

..... (TRM/MY)

THE TAPE RECORDER CENTRE



THE TAPE RECORDER CENTRE LTD., 82 HIGH HOLBORN, LONDON, W.C.1.

TELEPHONE: CHAncery 7401/8354

CLASSIFIED ADVERTISEMENTS

Rate.—One shilling per word: box numbers, 2s. 6d. extra. Payment with copy, which should be sent to Advertising Department, "TAPE Recording Magazine," Prestige House, 14-18, Holborn, London E.C.1.

NEW EQUIPMENT

TAPE RECORDERS SAVE FROM 30 per cent to 60 per cent on the original price. Large stocks of second-hand, new shop-soiled machines. All guaranteed. Obtainable on our **NO INTEREST TERMS**. Best part exchange allowances on your existing equipment. CALL, WRITE, PHONE today for free list. Quotation and details. Our Mail order covers the whole country.—R. E. W. Earlsfield Ltd., 266, Upper Tooting Road, London, S.W.17. BALham 9174-5.

FOR SALE

BLACKBURN has Lancashire's leading Hi-Fidelity/Tape Recorder stockists and Electronic Engineers at HOLDINGS AUDIO CENTRE, MINCING LANE/DARWIN STREET, BLACKBURN (Tel 59595).

£200 Shaub-Lorenz Hi-Fi 126 tracks, 46 hours tape recorder, and V.H.F. 4-wave radio for £65. New unused. 01-445 9581 or 01-445 2825.

MINIFLUX 4-Track stereophonic/monophonic record / playback heads. List Price 6 gns.—Special Offer 55/- each. MINIFLUX 4-Track stereophonic/monophonic Ferrite Erase Heads. List Price £3 10s.—Special Offer 32/6 each, or supplied together (one of each) at £3 17s. 6d. SKN4 1-Track stereophonic record/play heads for Transistor Circuits 55/- each. Also 1-track and full-track monophonic Ferrite Erase Heads complete with technical specifications. S.A.E. for details. LEE ELECTRONICS, 400 Edgware Rd., Paddington 5521.

30 per cent OFF BASF TAPE. LP 7-inch reel 1,800 ft. 33s. 3d.; DP 7-inch reel 2,400 ft. 52s. 6d. P. & P 5s. per order. W.S.L., 104, Norwood High Street, S.E.27.

20% CASH DISCOUNT on Hi-Fi equipment. Radiograms, Radios, Tape Recorders, Cameras, Typewriters, etc. Join England's largest Mail Order Club now and enjoy the advantages of bulk buying, send 5s. for membership card, catalogues, price lists or s.a.e. for free quotation and leaflets. C.B.A. (Dept. A5), 40, Cassio Road, Watford, Herts.

REPAIRS

OUR MODERN SERVICE DEPARTMENT equipped with the latest test equipment including a wow and flutter meter and multiplex Stereo Signal Generator is able to repair Hi Fi and Tape Recording Equipment to manufacturer's standard. TELESONIC LTD., 92, Tottenham Court Road, London, W.1. 01-636 8177.

TAPE DUBBING

E.R.S. RECORDS: TAPE/DISC Vari-groove High Level Recordings with WIDE FREQUENCY RANGE. Top quality pressings. 162, SHIRLAND ROAD, LONDON, W.9.

J. & B. RECORDINGS. Tape/disc. Cheap pressings. Quality recording. 14, Willows Avenue, Morden, Surrey. Mitcham 9952.

JOHN HASSELL RECORDINGS. Tape-to-Disc Service using latest high level disc-cutting system. Quality pressings made. Studio with Beststein Grand Mobile unit. 21, Nassau Road, London, S.W.13. RIVerside 7150.

TAPE TO DISC service. Specialists in Location recordings, Demos, Weddings, Sound Equipment, etc. Any distance. S.A.E. for leaflet. TRUSOUND Recording Services, 4, Hitchin Road, Shefford, Beds. Telephone: Shefford 355.

YOUR TAPES TO DISC, 7 in. 45—18s., 10 in. LP—48s., 12 in. LP—55s. 4-day postal service. Top professional quality. S.a.e. photo leaflet: DERBY STUDIOS, High Bank, Hawk St., Carnforth, Lancs.

TAPE EXCHANGES

FRIENDLY FOLK ASSOCIATION, Torquay (Est. 1943). Social introductions, Pen-friends, Book-lovers, Stamps, Photography, Tapesponding. Members 100 countries.

MAKE INTERESTING NEW FRIENDS. Trial introductions free. VCC, 34, Honeywell, London, S.W.11.

THE LONDON TAPE RECORDING CLUB had its tenth birthday last year. Our meetings, held monthly in the Charing Cross area, are lively, creative occasions, and prospective new members will be welcome. Please write for details to: The Secretary, Mr. C. Clements, 36 Hubert Road, London, E.6.

FAR AND WIDE RECORDING CLUB, Eccles, Maudstone. Details free.—SAE.

MISCELLANEOUS

HIGHEST CASH PRICES offered or good quality Tape Recorders and Hi-fi. See our advert page 204 this issue. R.E.W., 266-8, Upper Tooting Road, London, S.W.17.

TAPE RECORDS

ABSOLUTELY EVERY AMERICAN 4 TRACK STEREO TAPE released in America can be obtained through our special postal service. For complete and up-to-date catalogue of all releases send only 4s. to: MUSIC U.S.A., 146 Lower Baggot Street, Dublin 2, Ireland.

Every pre-recorded tape available in Britain is listed in the complete TELETAPE catalogue at 1s. 6d. post free.

Vast selection of Mono and Stereo tapes. Send now for your copy by return to: Mail Order Dept., TELETAPE Ltd., 11, Redvers Road, London, N.22, or call at our Marble Arch or Shaftesbury Avenue Showrooms.

Four-track Stereo Tapes are expensive! Join the W.S.L. Stereo Tape Library and enjoy every tape for only a few pence per day. **Worldwide Service**. Send 9d. postage for full details to: 104, Norwood High Street, London, S.E.27.

EDUCATIONAL

LEARN WHILE YOU SLEEP: GCE and Professional subjects. Languages, etc. Free booklet from THE SLEEP LEARNING ASSOCIATION, 14 Belsize Crescent, London, N.W.3. Tel.: SWI 6160.

PUBLICATIONS

NOW IN ITS SECOND REPRINT, Alan Beeby's informative handbook **SOUND EFFECTS ON TAPE**. Invaluable to all dramatists and recording-enthusiasts. Tells in practical terms not only what to do but also how and why. 3s. 6d. post free. Remittance with order to Print & Press Services, Prestige House, 14-18, Holborn London, E.C.1.

WANTED

WANTED. A Tape Recording of the Sound Track of the film WATERLOO BRIDGE. Box No. 480.

GOOD QUALITY TAPE RECORDERS PURCHASED FOR CASH. TELEPHONE 01-472 2185.

SITUATIONS VACANT

AGFA-GEVAERT LIMITED

EXPERIENCED SALES REPRESENTATIVE required for Magnetic Tape Division to cover Midlands and Northern Territory. Knowledge of tape and recording necessary qualification. Salary by negotiation. Car provided, expenses paid. Super-annuation Fund and free Life Assurance. Please write in strict confidence to the Personnel Manager, Agfa-Gevaert Ltd., Great West Road, Brentford, Middx.

UNIVERSITY OF LEEDS NUFFIELD FOREIGN LANGUAGES TEACHING MATERIALS PROJECT.

Applications are invited for the temporary post of TAPE EDITOR. Duties will include the editing of foreign language recordings under the direction of the course producers. Experience with recording equip-

ment and magnetic tape essential. Previous editing experience an advantage. Salary in accordance with age and experience.

Applications, giving full details of experience and qualifications and the names of two referees to: Publications Officer, 5, Lyddon Terrace, Leeds 2.

WIMBLEDON'S TAPE RECORDER CENTRE

SKILLED TAPE RECORDER REPAIRS carried out by expert personnel of many years' experience backed by extensive test equipment—Wow & Flutter Meter, Audio Valve Voltmeter, Audio Generator, Oscilloscope, etc. with final test performance figures quoted if required. Ferroglyph specialists.

Tape Recorder Centre TEL-LEE-RADIO 220 The Broadway, Wimbledon, S.W.19. 01-542 4946

MAILWAY LOW COST TAPES

Supplied in strong Boxes with free length of leader. Fully guaranteed.

7" Mylar 2400 ft.	21/-	5" Mylar 1200 ft.	16/6
7" Mylar 1800 ft.	16/3	5" Mylar 900 ft.	11/3
7" Mylar 1200 ft.	11/6	5" Mylar 600 ft.	9/6
7" Acetate 1800 ft.	12/6	5" Acetate 900 ft.	8/6
7" Acetate 1200 ft.	10/-	5" Acetate 600 ft.	8/-

Post and Packing 2/- per order. Send S.A.E. for Tape and Accessories Catalogue to "MAILWAY", 1, Icknield Street, Dunstable, Beds.

RAPID RECORDING SERVICE

L.P.s from your own tapes. (48-hour service)

Master Discs and pressings.

Recording Studio.

Mobile Recordings.

Associated Company—

EDUCATIONAL RECORDINGS LTD.

Is your mind managing you??

Do you often find it difficult to make decisions?

Do you brood over your troubles?

Send now for Psycho-tape No. S.T./1 "Mind Management.

Twenty other tapes on self-improvement.

Publications:—

"Sleep-learning, Its Theory, Application and Technique."

"Mental Power Through Sleep-suggestion."

"How to Get What You Want" by Sidney N. Bremer.

Brochures from

RAPID RECORDING SERVICE (Dept. TRM)
21 Bishops Close, London, E.17

Turn your tape recorder into a powerful learning machine

Send now for Catalogue of Accessories such as Time Switches, Pillow Speakers, Special Induction Tapes for Learning and Therapy, Endless Tape Cassette Repeaters, Language Courses, G.C.E. Courses etc. If you do not already have a tape recorder we can supply an all-British 3-speed model for only 28 gns. Credit terms available. Get with it! Take advantage of these new, simpler, faster educational techniques.

Send postcard to:

Institute of Tape Learning (TRM), 153, Fellows Road, London, N.W.3.
01-722-3314

The Berean Forward Movement

(NON-DENOMINATIONAL)

Loan of over 1,000 reliable expositions of the Bible available on tape (3 1/4 ips) for cost of postage only. For Bible Study groups or private meditation. Supporting literature also available. Details from: Miss R. Hammond (TRM), Burwood, Blofield, NORWICH, Norfolk. NOR 84Z.



To ALL OWNERS of
Tape Recorders!
YOU SAVE MONEY AND
PREVENT IMPORTS



High-grade Magnetic Recording Tape. Polyester and PVC. Specially coated. Sensitive. Clear and durable. Appreciated by discerning people.

STORED AT CORRECT TEMPERATURES.

Dear Sir,
Thank you for your service to us members of the Tape World.

S.T. Beds.

Also full Range of Triple Play. List Free. 'Scotch' Splicing Tape 4/6. 4" LP. 450' 5/-

Mora Trading Co. (T3)
Mora Works, Mora Road, N.W.2

Postage 1/6 per order.
Posted the same day.
Money-back gtd.

New	3"	5"	5 1/4"	7"
Standard Play each 3 for	150' 2/- 5/9	600' 5/6 16/-	850' 7/- 20/-	1200' 8/6 25/-
Long Play each 3 for	240' 3/- 8/6	900' 7/6 22/-	1200' 9/6 27/9	1800' 12/6 36/9
Double Play each 3 for	300' 4/3 12/3	1200' 11/- 32/3	1800' 15/- 44/-	2400' 19/9 58/3

LONDON microphones

Quality sound—at low cost

The London Microphone range offers you quality microphones, good characteristics—and good looks, too, at remarkably little cost. All made in Britain.



NEW to the range: LM 200S Dynamic cardioid microphone. Balanced output. Like its counterpart, the LM 200, it eliminates unwanted background noise. Gives good recordings even under difficult conditions, but with this important extra—easily-manipulated switch at point of recording.

	Low imp.	High imp.
LM 200S	£5.19.6	£6.15.0
LM 200	£4.19.6	£5.15.0
LM 100 (Omni)	£3. 3.0	£3.18.6

Home or overseas trade enquiries welcome. Write or ring for details:

LONDON MICROPHONE CO. LTD.

182/4, Camden Hill Road, London, W.8. Tel.: 01-727 0711 Telex 23894

ADVERTISEMENT INQUIRIES SERVICE

I should like further information about
Messrs 's advertisement

on page..... of TAPE Recording Magazine
about..... (product)

NAME.....

ADDRESS

.....

.....

.....

.....

.....
May 1968

This is a special service for readers of "TAPE Recording Magazine." It enables you without cost to get fuller information about those products in which you are particularly interested. Fill in one coupon below for each inquiry, with your name and address in block capitals in each case. Then cut out the whole of this section, following the dotted line, fold as indicated overleaf and post to us.

I should like further information about
Messrs 's advertisement

on page..... of TAPE Recording Magazine
about..... (product)

NAME.....

ADDRESS

.....

.....

.....

.....
May 1968

I should like further information about
Messrs 's advertisement

on page..... of TAPE Recording Magazine
about..... (product)

NAME.....

ADDRESS

.....

.....

.....

.....
May 1968

I should like further information about
Messrs 's advertisement

on page..... of TAPE Recording Magazine
about..... (product)

NAME.....

ADDRESS

.....

.....

.....

.....
May 1968

I should like further information about
Messrs 's advertisement

on page..... of TAPE Recording Magazine
about..... (product)

NAME.....

ADDRESS

.....

.....

.....

.....
May 1968

TAPE HANDBOOKS

FOR THE NEWCOMER *as well as the* ENTHUSIAST OF LONG STANDING

Advice on Buying a Tape Recorder
by J. F. Ling.

2s. 6d. (USA \$0.65) post free.

Chapters on preliminary considerations, tape deck, amplifier, etc.

Introduction to the Tape Recorder
by C. Langton.

3s. 6d. (USA \$0.75) post free.

To help the newcomer to a working knowledge and maximum enjoyment.

Sound Effects on Tape by Alan Edward Beeby.

3s. 6d. (USA \$0.75) post free.

How to achieve realistic effects simply and economically.

How to Record Weddings by Paul Addinsell.

3s. (USA \$0.70) post free.

Illustrated. Covers preparation, mike positioning, equipment, etc.

MAIL ORDER ONLY

Tape and Cine by John Aldred.

3s. (USA \$0.70) post free.

With practical advice on synchronising methods, etc.

The Law and Your Tape Recorder by Andrew Phelan (Barrister).

3s. 6d. (USA \$0.75) post free.

Interprets the law in UK for the tape recorder owner; what is free, forbidden, restricted.

Hi-Fi for the Music Lover by Edward Greenfield.

3s. (USA \$0.70) post free.

Aims at giving the music lover basic technical know-how.

REMITTANCE MUST ACCOMPANY ORDERS

Send Orders to—

PRINT & PRESS SERVICES LTD.

Tape Bookshop, Prestige House,
14-18, Holborn, E.C.1.

TAPE BOOKSHOP

CUT ALONG DOTTED LINE

POSTAGE
WILL BE
PAID BY
PRINT AND
PRESS
SERVICES
LIMITED

TAPE RECORDING MAGAZINE,

PRESTIGE HOUSE,

14-18 HOLBORN,

LONDON, E.C.1

BUSINESS REPLY FOLDER
Licence No. ND 922

THIRD FOLD HERE

SECOND FOLD HERE

NO POSTAGE
STAMP
NECESSARY
IF POSTED
IN GREAT
BRITAIN OR
NORTHERN
IRELAND

FLAP A

FLAP B

FIRST FOLD ALONG THIS LINE

Fold along lines as indicated and then tuck Flap A into Flap B

Where can you get a **STEREO TAPE RECORDER** with this spec., and at this price, but from **HEATHKIT**

ONLY £45 18 0 kit £55 10s. Ready to us

FOR THIS SPECIFICATION

● $\frac{1}{2}$ track stereo or mono record and playback at $7\frac{1}{2}$, $3\frac{3}{4}$ and $1\frac{1}{2}$ ips ● Sound-on-sound and sound-with-sound capabilities ● Stereo record, stereo playback, mono record and playback on either channel ● 18 transistor circuit for cool, instant and dependable operation ● Moving coil record level indicator ● Digital counter with thumb-wheel zero reset ● Stereo microphone and auxiliary inputs and controls, speaker headphone and external amplifier outputs... front panel mounted for easy access ● Push-button controls for operational modes ● Built-in stereo power amplifier giving 4 watts rms per channel ● Two high efficiency 8 in. by 5 in. speakers ● Operates on 230V ac supply.



The New Heathkit Stereo Tape Recorder has built-in audio amplifiers and speakers giving you complete recording and playback facilities in one compact cabinet that's easy to carry from room to room or house to house. The kit is complete with a good quality moving coil mono microphone, $5\frac{3}{4}$ " spool of long play (1,200 feet) magnetic tape and one spare spool.

Versatile Recording Facilities. The Heathkit Recorder can record "live" from microphones or from auxiliary sources such as radio tuners, records, etc., and playback... in $\frac{1}{2}$ track stereo or mono at either $7\frac{1}{2}$, $3\frac{3}{4}$ or $1\frac{1}{2}$ ips. And you can make sound-on-sound recordings by playing back through one channel and recording through the other channel... stereo record and playback... mono record and playback on either channel.

Other Features. Two audio amplifiers produce 4 watts rms per channel into two high efficiency 8" x 5" speakers giving high quality sound in a portable instrument. Gives startling realism to stereo reproduction... jacks are provided for connecting to external speakers if required. Moving coil level indicator for visual monitoring of recorded signal level. Separate inputs and controls for microphones and auxiliaries, separate outputs for speakers/headphones and external amplifiers... all front-panel mounted for easy access. Ganged controls for easy operation. All transistor circuitry... your assurance of cool, instant operation and long, reliable life.

So Easy to Build... the Heathkit way! Simple step-by-step instructions and large pictorial diagrams in the manual show you where every part goes... tell you exactly what to do... guide you every step of the way. No special skills or technical knowledge required. Printed circuit board construction ensures speedy and easy assembly with consistent performance.

See Britain's Finest Range of Electronics in the latest **FREE** Catalogue

To **DAYSTROM LTD.**, Gloucester. Tel.: 29451 tick

FREE BRITISH HEATHKIT CATALOGUE

Full details of Model(s).....

Name

Address

(Block capitals please) T.4

Please send Free Heathkit Catalogue to my Friend

Name

Address

..... T.4

**TAPE
RECORDER
CENTRE**

KENT AND S.E. LONDON

Tandberg

SPECIALISTS

COMPLETE RANGE IN STOCK

Akai, Ampex, B & O, Brenell, E.M.I., Elizabethan, Ferguson, Ferrograph, Grundig, Loewe-Opta, National, Philips, Reps, Revox, Sanyo, Sharp, Sony, Telefunken, Truvox, Uher, Van Der Molen, Vortexion, Wyndson, etc., together with a wonderful range of Hi-Fi equipment

WHEREVER YOU LIVE IN KENT OR S.E. LONDON
THE NUSOUND TAPE RECORDER CENTRE IS YOUR
BEST CHOICE FOR

- PERSONAL AND EXPERT ADVICE
- EASY HIRE PURCHASE TERMS
- GENEROUS PART EXCHANGES
- FREE AFTER SALES SERVICING

**36, LEWISHAM HIGH STREET,
LONDON, SE.13**

Telephone: LEE GREEN 2399

(Situated only one minute from Lewisham Station)



Sanyo puts you in the world class



This is the Superb new MR990 stereo tape recorder

- Full fidelity
- Vertical operation
- 4 track
- Sound with sound

Tape speeds

7½ in/sec (19cm/sec)
3¾ in/sec (9.5cm/sec)
1½ in/sec (4.8cm/sec)

Playing time

96 min x 2 at 7½ ips
(stereo 7" 1,200 ft. tape)
192 min x 2 at 3¾ ips
(stereo 7" 1,200 ft. tape)
384 min at 1½ ips
(stereo 7" 1,200 ft. tape)

Frequency response
7½ ips : 20-21,000 c/s

(-3db 30-16,000 c/s)
3¾ ips : 30-13,000 c/s
1½ ips : 30-9,000 c/s

Wow & Flutter

7½ ips : 0.15% R.M.S.
3¾ ips : 0.20% R.M.S.
1½ ips : 0.30% R.M.S.

Output Power

Music : 10W x 2
Undistorted : 5W x 2

Erase rate
Less than 65db

Weight

35.2 lbs (17kg)

Accessories

Microphone x 2,
Recording tape 7",
Empty reel 7",
Patch cord x 2,
Reel stopper x 2,
Splicing tape,
Capstan sleeve,
Microphone stand x 2.

SANYO

RELIABILITY IS BUILT IN